



MTP



MTP-G



MTP-X



MTP-AT



## CHARACTERISTICS

- Functioning by roughness; installation by controlled torque.
- Use for medium loads.
- Easy installation.
- Use in cracked and uncracked concrete, with or without fibres.
- Use for seismic loads C1 & C2.
- Use for static or quasi-static loads.
- Approved for fire resistance R30 to R120
- Versions in galvanized steel and Atlantis coating.
- Vds available for sized from M8 to M20.
- Certificate VdS CEA 4001:2021-01 for sprinklers
- FM available for MTP-X for sizes from M10 to M16
- Available in INDEXcal.

## RECOMMENDED TENSION RESISTANCES IN UNCRACKED CONCRETE [kg]

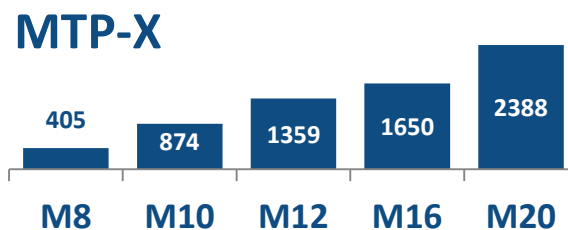
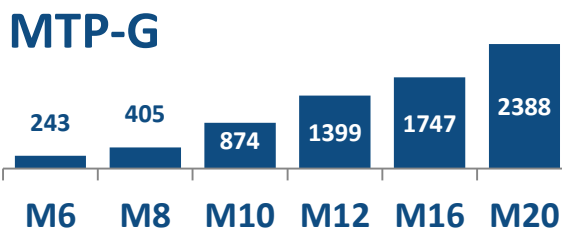
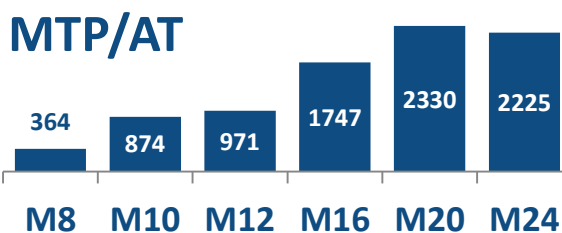

## BASE MATERIALS



## DRILL CONDITIONS

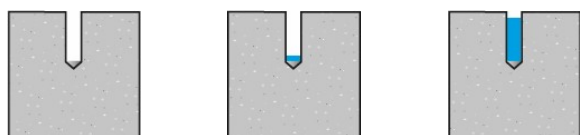

DRY

WET

FLOODED

## APPLICATION EXAMPLES

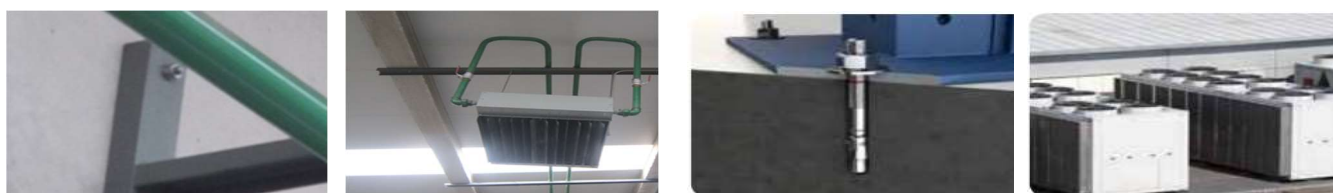

1. RANGE

ITEM	CODE	SIZES	PHOTO	COMPONENT	MATERIAL
1	MTP	M8 to M24		Wedgebolt Clip Nut Washer	Carbon steel, galvanized $\geq 5 \mu\text{m}$ AISI 201 stainless steel DIN 934, galvanized $\geq 5 \mu\text{m}$ DIN 125 o DIN 9021, galvanized $\geq 5 \mu\text{m}$
2	MTP-G	M6 to M20		Wedgebolt Clip Nut Washer	Carbon steel, Atlantis C3-L $\geq 40 \mu\text{m}$ AISI 201 stainless steel DIN 934, Atlantis C3-L $\geq 40 \mu\text{m}$ DIN 125 o DIN 9021, Atlantis $\geq 40 \mu\text{m}$
3	MTP-X	M8 to M20		Wedgebolt Clip Nut Washer	Carbon steel, galvanized $\geq 5 \mu\text{m}$ Carbon steel, Atlantis C3-L $\geq 15 \mu\text{m}$ DIN 934, galvanized $\geq 5 \mu\text{m}$ DIN 125 o DIN 9021, galvanized $\geq 5 \mu\text{m}$
4	MTP-AT	M8 to M24		Wedgebolt Clip Nut Washer	Carbon steel, Atlantis C4-M $\geq 8 \mu\text{m}$ AISI 201 stainless steel DIN 934, Atlantis C4-M $\geq 8 \mu\text{m}$ DIN 125 o DIN 9021, Atlantis $\geq 8 \mu\text{m}$

2. ACCESORIES

ITEM	CODE	PHOTO	DESCRIPTION
1	DOMTA		Tool for anchor fixing using percussion drilling machine.
2	TP-MT		Plastic plug for MT, colors black and white (M6 to M16)

3. INSTALLATION DATA

3.1 INSTALLATION DRAWING

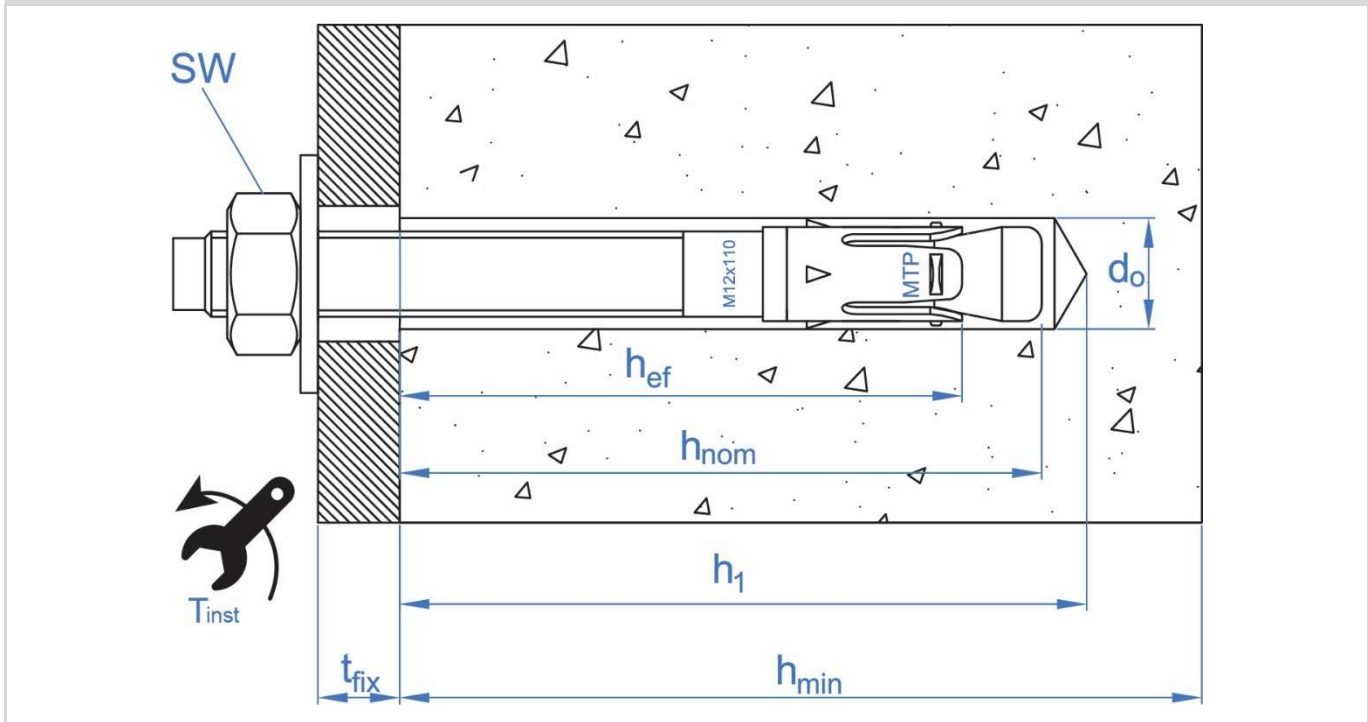

3.2 INSTALLATION PARAMETERS

Family	Code	Size	Assessed	Drill bit diameter	Fixture clearance hole	Torque	Minimum concrete thickness	Depth of drill hole $\geq$	Installation depth	Effective anchorage depth	Thickness of fixture $\leq$
[--]	[--]	[--]	ETE	$d_0$ [mm]	$d_f$ [mm]	$T_{inst}$ [Nm]	$h_{min}$ [mm]	$h_1$ [mm]	$h_{nom}$ [mm]	$h_{ef}$ [mm]	$t_{fix}$ [mm]
MTP	AP08050	M8x50		8	9	20	100	40	37	30	2
	AP08075	M8x75	✓					9	2		
	AP08095	M8x95	✓					60	55	48	29
	AP08115	M8x115	✓					49			
	AP10090	M10x90	✓	10	12	40	120	75	68	60	10
	AP10105	M10x105	✓								25
	AP10115	M10x115	✓								35
	AP10135	M10x135	✓								55
	AP10165	M10x165	✓								85
	AP10185	M10x185	✓								105
	AP12080	M12x80		12	14	60	100	65	60	50	4
	AP12100	M12x100	✓				4				
	AP12110	M12x110	✓				14				
	AP12120	M12x120	✓				24				
	AP12130	M12x130	✓				34				
	AP12150	M12x150	✓				54				
	AP12180	M12x180	✓				84				
	AP12200	M12x200	✓				104				
	AP16145	M16x145	✓	16	18	100	170	105	97	85	28
	AP16175	M16x175	✓								58
	AP16220	M16x220	✓								103
	AP16250	M16x250	✓								133
	AP20170	M20x170	✓	20	22	200	200	125	114	100	32
	AP20200	M20x200	✓								62
	AP24205	M24x205	✓	24	26	250	250	155	143	125	35
	AP24235	M24x235	✓								65

3.2 INSTALLATION PARAMETERS

Family	Code	Size	Assessed	Drill bit diameter	Fixture clearance hole	Torque	Minimum concrete thickness	Depth of drill hole $\geq$	Installation depth	Effective anchorage depth	Thickness of fixture $\leq$			
				$d_0$	$d_r$	$T_{inst}$	$h_{min}$	$h_1$	$h_{nom}$	$h_{ef}$	$t_{fix}$			
				[mm]	[mm]	[Nm]	[mm]	[mm]	[mm]	[mm]	[mm]			
MTP-G	APG06060	M6x60		6	7	7	100	50	46	40	10			
	APG06070	M6x70									20			
	APG06100	M6x100									50			
	APG08050	M8x50		8	9	15	100	40	37	30	2			
	APG08060	M8x60									12			
	APG08075	M8x75	✓					9						
	APG08095	M8x95	✓					29						
	APG08115	M8x115	✓					49						
	APG10070	M10x70		10	12	40	100	60	53	45	5			
	APG10090	M10x90	✓								10			
	APG10105	M10x105	✓				25							
	APG10115	M10x115	✓				35							
	APG10135	M10x135	✓				55							
	APG10150	M10x150	✓				70							
	APG10165	M10x165	✓				85							
	APG10185	M10x185	✓				105							
	APG12080	M12x80					12	14	60	100	65	60	50	4
	APG12090	M12x90												14
	APG12110	M12x110	✓	14										
	APG12130	M12x130	✓	34										
	APG12150	M12x150	✓	54										
	APG12160	M12x160	✓	64										
	APG12180	M12x180	✓	84										
	APG12200	M12x200	✓	104										
	APG16125	M16x125	✓	16	18	100				170	105	97	85	8
	APG16145	M16x145	✓											28
	APG16175	M16x175	✓				58							
	APG16220	M16x220	✓				103							
	APG16250	M16x250	✓				133							
	APG20170	M20x170	✓				20	22	200					200
APG20200	M20x200	✓	62											

3.2 INSTALLATION PARAMETERS

Family	Code	Size	Assessed	Drill bit diameter	Fixture clearance hole	Torque	Minimum concrete thickness	Depth of drill hole $\geq$	Installation depth	Effective anchorage depth	Thickness of fixture $\leq$
[--]	[--]	[--]	ETA	$d_0$	$d_f$	$T_{inst}$	$h_{min}$	$h_1$	$h_{nom}$	$h_{ef}$	$t_{fix}$
				[mm]	[mm]	[Nm]	[mm]	[mm]	[mm]	[mm]	[mm]
MTP-X	APX08050	M8x50		8	9	15	80	40	37	30	2
	APX08075	M8x75	✓					9			
	APX08080	M8x80	✓					14			
	APX08095	M8x95	✓					29			
	APX08115	M8x115	✓					49			
	APX10090	M10x90	✓	10	12	40	90	75	68	60	10
	APX10105	M10x105	✓								25
	APX10115	M10x115	✓								35
	APX10135	M10x135	✓								55
	APX10165	M10x165	✓								85
	APX10185	M10x185	✓								100
	APX12080	M12x80		12	14	60	100	65	60	50	4
	APX12100	M12x100	✓				4				
	APX12110	M12x110	✓				14				
	APX12120	M12x120	✓				24				
	APX12130	M12x130	✓				34				
	APX12150	M12x150	✓				54				
	APX12180	M12x180	✓				84				
	APX12200	M12x200	✓				104				
	APX12220	M12x220	✓				124				
	APX12255	M12x255	✓				159				
	APX16145	M16x145	✓	16	18	100	130	105	97	85	28
	APX16175	M16x175	✓								58
	APX16220	M16x220	✓								103
	APX16250	M16x250	✓								133
	APX20170	M20x170	✓	20	22	200	150	125	114	100	32
APX20200	M20x200	✓	62								

3.2 INSTALLATION PARAMETERS

Family	Code	Size	Assessed	Drill bit diameter	Fixture clearance hole	Torque	Minimum concrete thickness	Depth of drill hole $\geq$	Installation depth	Effective anchorage depth	Thickness of fixture $\leq$
[--]	[--]	[--]	ETA	$d_0$ [mm]	$d_f$ [mm]	$T_{inst}$ [Nm]	$h_{min}$ [mm]	$h_1$ [mm]	$h_{nom}$ [mm]	$h_{ef}$ [mm]	$t_{fix}$ [mm]
MTP-AT	APAT08075	M8x75	✓	8	9	20	100	60	55	48	9
	APAT08095	M8x95	✓								29
	APAT08115	M8x115	✓								49
	APAT10090	M10x90	✓	10	12	40	120	75	68	60	10
	APAT10105	M10x105	✓								25
	APAT10115	M10x115	✓								35
	APAT10135	M10x135	✓								55
	APAT10165	M10x165	✓								85
	APAT10185	M10x185	✓								105
	APAT12100	M12x100	✓								12
	APAT12110	M12x110	✓	14							
	APAT12120	M12x120	✓	24							
	APAT12130	M12x130	✓	34							
	APAT12150	M12x150	✓	54							
	APAT12180	M12x180	✓	84							
	APAT12200	M12x200	✓	104							
	APAT16145	M16x145	✓	16	18	100	170	105	97	85	28
	APAT16175	M16x175	✓								58
	APAT16220	M16x220	✓								103
	APAT20170	M20x170	✓	20	22	200	200	125	114	100	32
APAT20200	M20x200	✓	62								

3.3 INSTALLATION DISTANCES

Family	Code	Size	Assessed	Minimum allowable spacing		Minimum allowable edge distance		Characteristic spacing (concrete cone)	Characteristic edge distance (concrete cone)	Characteristic spacing (splitting)	Characteristic edge distance (splitting)
				$S_{min} (C \geq)$	$C_{min} (S \geq)$	$S_{cr,N}$	$C_{cr,N}$				
MTP	AP08050	M8x50						90	45	288	144
	AP08075	M8x75	✓	40	55	45	55	144	72	288	144
	AP08095	M8x95	✓								
	AP08115	M8x115	✓								
	AP10090	M10x90	✓								
	AP10105	M10x105	✓								
	AP10115	M10x115	✓	40	70	45	90	180	90	300	150
	AP10135	M10x135	✓								
	AP10165	M10x165	✓								
	AP10185	M10x185	✓								
	AP12080	M12x80						150	75	350	175
	AP12100	M12x100	✓								
	AP12110	M12x110	✓								
	AP12120	M12x120	✓	60	75	55	110	210	105	350	175
	AP12130	M12x130	✓								
	AP12150	M12x150	✓								
	AP12180	M12x180	✓								
	AP12200	M12x200	✓								
	AP16145	M16x145	✓								
	AP16175	M16x175	✓	65	95	70	115	255	128	425	213
AP16220	M16x220	✓									
AP16250	M16x250	✓									
AP20170	M20x170	✓	95	105	95	105	300	150	500	250	
AP20200	M20x200	✓									
AP24205	M24x205	✓	125	125	125	125	375	188	560	280	
AP24235	M24x235	✓									
MTP-G	APG06060	M6x60									
	APG06070	M6x70		40	55	45	55	120	60	200	100
	APG06100	M6x100									
	APG08050	M8x50						90	45	288	144
	APG08060	M8x60									
	APG08075	M8x75	✓	40	55	45	55	144	72	288	144
	APG08095	M8x95	✓								
	APG08115	M8x115	✓								
	APG10070	M10x70						135	68	300	150
	APG10090	M10x90	✓								
	APG10105	M10x105	✓								
	APG10115	M10x115	✓	40	70	45	90	180	90	300	150
	APG10135	M10x135	✓								
	APG10150	M10x150	✓								
	APG10165	M10x165	✓								
APG10185	M10x185	✓									

3.3 INSTALLATION DISTANCES





Family	Code	Size	Assessed	Minimum allowable spacing		Minimum allowable edge distance		Characteristic spacing (concrete cone)	Characteristic edge distance (concrete cone)	Characteristic spacing (splitting)	Characteristic edge distance (splitting)
				$S_{min}(C \geq)$	$C_{min}(S \geq)$	$S_{cr,N}$	$C_{cr,N}$				
MTP-G	APG12080	M12x80		60	75	55	110	150	75	350	175
	APG12090	M12x90									
	APG12110	M12x110	✓								
	APG12120	M12x120	✓								
	APG12130	M12x130	✓	65	95	70	115	255	128	510	255
	APG12150	M12x150	✓								
	APG12160	M12x160	✓								
	APG12180	M12x180	✓								
	APG12200	M12x200	✓								
	APG16125	M16x125	✓								
	APG16145	M16x145	✓	95	105	95	105	300	150	600	300
	APG16175	M16x175	✓								
	APG16220	M16x220	✓								
	APG16250	M16x250	✓								
APG20170	M20x170	✓	95	105	95	105	300	150	600	300	
APG20200	M20x200	✓									
MTP-X	APX08050	M8x50		40	55	45	55	90	45	288	144
	APX08075	M8x75	✓								
	APX08080	M8x80	✓								
	APX08095	M8x95	✓								
	APX08115	M8x115	✓	40	70	45	90	135	68	300	150
	APX10090	M10x90	✓								
	APX10105	M10x105	✓								
	APX10115	M10x115	✓								
	APX10135	M10x135	✓								
	APX10165	M10x165	✓								
	APX10185	M10x185	✓	60	75	55	110	150	75	350	175
	APX12080	M12x80									
	APX12100	M12x100	✓								
	APX12110	M12x110	✓								
	APX12120	M12x120	✓								
	APX12130	M12x130	✓								
	APX12150	M12x150	✓								
	APX12180	M12x180	✓								
	APX12200	M12x200	✓								
	APX12220	M12x220	✓								
	APX12255	M12x250	✓								
	APX16145	M16x145	✓					65	95	70	115
	APX16175	M16x175	✓								
	APX16220	M16x220	✓								
APX16250	M16x250	✓									
APX20170	M20x170	✓	95	105	95	105	300	150	600	300	
APX20200	M20x200	✓									

3.3 INSTALLATION DISTANCES

Family	Code	Size	Assessed	Minimum allowable spacing		Minimum allowable edge distance		Characteristic spacing (concrete cone)	Characteristic edge distance (concrete cone)	Characteristic spacing (splitting)	Characteristic edge distance (splitting)
				$S_{min}$ (C ≥)	$C_{min}$ (S ≥)	$S_{cr,N}$	$C_{cr,N}$	$S_{cr,sp}$	$C_{cr,sp}$		
MTP-AT	AP08075	M8x75	✓	40	55	45	55	144	72	288	144
	AP08095	M8x95	✓								
	AP08115	M8x115	✓								
	AP10090	M10x90	✓	40	70	45	90	180	90	300	150
	AP10105	M10x105	✓								
	AP10115	M10x115	✓								
	AP10135	M10x135	✓								
	AP10165	M10x165	✓								
	AP10185	M10x185	✓								
	AP12100	M12x100	✓	60	75	55	110	210	105	350	175
	AP12110	M12x110	✓								
	AP12120	M12x120	✓								
	AP12130	M12x130	✓								
	AP12150	M12x150	✓								
	AP12180	M12x180	✓								
	AP12200	M12x200	✓	65	95	70	115	255	128	425	213
	AP16145	M16x145	✓								
	AP16175	M16x175	✓								
AP16220	M16x220	✓	95	105	95	105	300	150	500	250	
AP20170	M20x170	✓									
AP20200	M20x200	✓									

3.4. SEISMIC LOAD ASSESSMENT

Family	Code	Size	Assessed	C1	C2	Family	Code	Size	Assessed	C1	C2
[--]	[--]	[--]	ETA	[--]	[--]	[--]	[--]	[--]	ETA	[--]	[--]
MTP	AP08050	M8x50	--	--	--	MTP-X	APX08050	M8x50	--	--	--
	AP08075	M8x75	✓	--	--		APX08075	M8x75	✓	✓	--
	AP08095	M8x95	✓	--	--		APX08080	M8x80	✓	✓	--
	AP08115	M8x115	✓	--	--		APX08095	M8x95	✓	✓	--
	AP10090	M10x90	✓	✓	--		APX08115	M8x115	✓	✓	--
	AP10105	M10x105	✓	✓	--		APX10090	M10x90	✓	✓	✓
	AP10115	M10x115	✓	✓	--		APX10105	M10x105	✓	✓	✓
	AP10135	M10x135	✓	✓	--		APX10115	M10x115	✓	✓	✓
	AP10165	M10x165	✓	✓	--		APX10135	M10x135	✓	✓	✓
	AP10185	M10x185	✓	✓	--		APX10165	M10x165	✓	✓	✓
	AP12080	M12x80	--	--	--		APX10185	M10x185	✓	✓	✓
	AP12100	M12x100	✓	✓	✓		APX12080	M12x80	--	--	--
	AP12110	M12x110	✓	✓	✓		APX12100	M12x100	✓	✓	✓
	AP12120	M12x120	✓	✓	✓		APX12110	M12x110	✓	✓	✓
	AP12130	M12x130	✓	✓	✓		APX12120	M12x120	✓	✓	✓
	AP12150	M12x150	✓	✓	✓		APX12130	M12x130	✓	✓	✓
	AP12180	M12x180	✓	✓	✓		APX12150	M12x150	✓	✓	✓
	AP12200	M12x200	✓	✓	✓		APX12180	M12x180	✓	✓	✓
	AP16145	M16x145	✓	✓	✓		APX12200	M12x200	✓	✓	✓
	AP16175	M16x175	✓	✓	✓		APX12220	M12x220	✓	✓	✓
AP16220	M16x220	✓	✓	✓	APX12255	M12x250	✓	✓	✓		
AP16250	M16x250	✓	✓	✓	APX16145	M16x145	✓	✓	--		
AP20170	M20x170	✓	--	--	APX16175	M16x175	✓	✓	--		
AP20200	M20x200	✓	--	--	APX16220	M16x220	✓	✓	--		
AP24205	M24x205	✓	--	--	APX16250	M16x250	✓	✓	--		
AP24235	M24x235	✓	--	--	APX20170	M20x170	✓	✓	✓		
APG06060	M6x60	--	--	--	APX20200	M20x200	✓	✓	✓		
APG06070	M6x70	--	--	--	APAT08075	M8x75	✓	--	--		
APG06100	M6x100	--	--	--	APAT08095	M8x95	✓	--	--		
APG08050	M8x50	--	--	--	APAT08115	M8x115	✓	--	--		
APG08060	M8x60	--	--	--	APAT10090	M10x90	✓	✓	--		
APG08075	M8x75	✓	✓	--	APAT10105	M10x105	✓	✓	--		
APG08095	M8x95	✓	✓	--	APAT10115	M10x115	✓	✓	--		
APG08115	M8x115	✓	✓	--	APAT10135	M10x135	✓	✓	--		
APG10070	M10x70	--	--	--	APAT10165	M10x165	✓	✓	--		
APG10090	M10x90	✓	✓	--	APAT10185	M10x185	✓	✓	--		
APG10105	M10x105	✓	✓	--	APAT12100	M12x100	✓	✓	✓		
APG10115	M10x115	✓	✓	--	APAT12110	M12x110	✓	✓	✓		
APG10135	M10x135	✓	✓	--	APAT12120	M12x120	✓	✓	✓		
APG10150	M10x150	✓	✓	--	APAT12130	M12x130	✓	✓	✓		
APG10165	M10x165	✓	✓	--	APAT12150	M12x150	✓	✓	✓		
APG10185	M10x185	✓	✓	--	APAT12180	M12x180	✓	✓	✓		
APG12080	M12x80	--	--	--	APAT12200	M12x200	✓	✓	✓		
APG12090	M12x90	--	--	--	APAT16145	M16x145	✓	✓	✓		
APG12110	M12x110	✓	✓	✓	APAT16175	M16x175	✓	✓	✓		
APG12120	M12x120	✓	✓	✓	APAT16220	M16x220	✓	✓	✓		
APG12130	M12x130	✓	✓	✓	APAT20170	M20x170	✓	--	--		
APG12150	M12x150	✓	✓	✓	APAT20200	M20x200	✓	--	--		
APG12160	M12x160	✓	✓	✓							
APG12180	M12x180	✓	✓	✓							
APG12200	M12x200	✓	✓	✓							
APG16125	M16x125	✓	✓	✓							
APG16145	M16x145	✓	✓	✓							
APG16175	M16x175	✓	✓	✓							
APG16220	M16x220	✓	✓	✓							
APG16250	M16x250	✓	✓	✓							
APG20170	M20x170	✓	✓	✓							
APG20200	M20x200	✓	✓	✓							

<b>4. INSTALLATION PROCEDURE</b>	
	<p><b>1. DRILLING</b></p> <p>Check the concrete base is compacted and porosity is insignificant. Suitable for dry, wet and flooded drill holes. Use drill in hammer mode. Drill to the specified diameter and depth values.</p>
	<p><b>2. BLOW AND CLEAN</b></p> <p>Clean the drill holes completely of dust and fragments. Use air pump and brush.</p>
	<p><b>3. INSTALL</b></p> <p>Insert the anchor in the hole until the red ring mark is flat with concrete surface. Use hammer in case of need; DOMTA tool could be used alternatively. The installation could be done through the fixture baseplate.</p>
	<p><b>4. APPLY THE TORQUE</b></p> <p>Apply nominal installation torque using a torque wrench. Once installed it can be verified the total length of the anchor though the letter on bolt tip.</p>

**5. RESISTANCES**

Resistances in concrete class C20/C25 for an isolated anchor, without spacing or concrete edge distance effects, for static or quasi-static loads are indicated in the following table:

**5.1 CHARACTERISTIC RESISTANCE [kN]**

General parameters					Uncracked concrete		Cracked concrete	
					Tension	Shear	Tension	Shear
Family	Code	Size	Assessed	Letter on the head tip	N <sub>Rk</sub>	V <sub>Rk</sub>	N <sub>Rk</sub>	V <sub>Rk</sub>
MTP	AP08050	M8x50		A	4,51	<b>8,08</b>	3,22	<b>5,66</b>
	AP08075	M8x75	✓	C	9,00	<u>11,90</u>	5,00	<b>11,45</b>
	AP08095	M8x95	✓	E				
	AP08115	M8x115	✓	G				
	AP10090	M10x90	✓	E	18,00	<u>20,30</u>	9,50	<u>20,30</u>
	AP10105	M10x105	✓	F				
	AP10115	M10x115	✓	G				
	AP10135	M10x135	✓	H				
	AP10165	M10x165	✓	K				
	AP10185	M10x185	✓	L				
	AP12080	M12x80		D	12,06	<u>29,50</u>	8,60	<b>24,35</b>
	AP12100	M12x100	✓	E	20,00	<u>29,50</u>	12,00	<u>29,50</u>
	AP12110	M12x110	✓	F				
	AP12120	M12x120	✓	G				
	AP12130	M12x130	✓	H				
	AP12150	M12x150	✓	I				
	AP12180	M12x180	✓	L				
	AP12200	M12x200	✓	M				
	AP16145	M16x145	✓	I	36,00	<u>54,90</u>	25,00	<b>53,97</b>
	AP16175	M16x175	✓	K				
AP16220	M16x220	✓	O					
AP16250	M16x250	✓	Q					
AP20170	M20x170	✓	K	48,00	<u>85,70</u>	32,00	<b>68,87</b>	
AP20200	M20x200	✓	M					
AP24205	M24x205	✓	N	55,00	<u>84,70</u>	35,00	<b>96,25</b>	
AP24235	M24x235	✓	P					
MTP-G	APG06060	M6x60		B	6,00	<u>6,04</u>	--	--
	APG06070	M6x70		C				
	APG06100	M6x100		E				
	APG08050	M8x50		A	4,51	<b>8,08</b>	3,22	<b>5,66</b>
	APG08060	M8x60		B				
	APG08075	M8x75	✓	C				
	APG08095	M8x95	✓	E				
	APG08115	M8x115	✓	G	10,00	<u>11,90</u>	6,00	<b>11,45</b>
	APG10070	M10x70		C				
	APG10090	M10x90	✓	E	6,70	<u>20,30</u>	4,78	<u>20,30</u>
	APG10105	M10x105	✓	F				
	APG10115	M10x115	✓	G				
	APG10135	M10x135	✓	H				
	APG10150	M10x150	✓	I				
	APG10165	M10x165	✓	K				
	APG10185	M10x185	✓	L				
APG10185	M10x185	✓	L	18,00				

General parameters					Uncracked concrete		Cracked concrete					
					Tension	Shear	Tension	Shear				
Family	Code	Size	Assessed	Letter on the head tip	N <sub>Rk</sub>	V <sub>Rk</sub>	N <sub>Rk</sub>	V <sub>Rk</sub>				
MTP-G	APG12080	M12x80		D	12,06	<u>29,50</u>	8,60	<b>24,35</b>				
	APG12090	M12x90		E								
	APG12110	M12x110	✓	E	<b>28,81</b>	<u>29,50</u>	16,00	<u>29,50</u>				
	APG12130	M12x130	✓	H								
	APG12150	M12x150	✓	I								
	APG12160	M12x160	✓	J								
	APG12180	M12x180	✓	L								
	APG12200	M12x200	✓	M								
	APG16125	M16x125	✓	G	36,00	<u>54,90</u>	<b>27,00</b>	<b>53,97</b>				
	APG16145	M16x145	✓	I								
	APG16175	M16x175	✓	K								
	APG16220	M16x220	✓	O								
	APG16250	M16x250	✓	Q								
	APG20170	M20x170	✓	K					<b>49,19</b>	<u>85,70</u>	30,00	<b>68,87</b>
	APG20200	M20x200	✓	M								
	MTP-X	APX08050	M8x50		A	4,51	<b>8,08</b>	3,22	<b>5,66</b>			
APX08075		M8x75	✓	C	10,00	<u>11,90</u>	7,00	<b>11,45</b>				
APX08080		M8x80	✓	D								
APX08095		M8x95	✓	E								
APX08115		M8x115	✓	G								
APX10090		M10x90	✓	E					18,00	<u>20,30</u>	11,00	<u>20,30</u>
APX10105		M10x105	✓	F								
APX10115		M10x115	✓	G								
APX10135		M10x135	✓	H								
APX10165		M10x165	✓	K								
APX10185		M10x185	✓	L								
APX12080		M12x80		D	10,05	<b>17,39</b>	7,16	<b>12,17</b>				
APX12100		M12x100	✓	E	28,00	<u>29,50</u>	15,00	<u>29,50</u>				
APX12110		M12x110	✓	F								
APX12120		M12x120	✓	G								
APX12130		M12x130	✓	H								
APX12150		M12x150	✓	I								
APX12180		M12x180	✓	L								
APX12200		M12x200	✓	M								
APX12220		M12x220	✓	O								
APX12255		M12x255	✓	R								
APX16145		M16x145	✓	I					34,00	<u>54,90</u>	<b>26,99</b>	<b>53,97</b>
APX16175		M16x175	✓	K								
APX16220		M16x220	✓	O								
APX16250		M16x250	✓	Q								
APX20170		M20x170	✓	K	<b>49,19</b>	<u>85,70</u>	<b>34,44</b>	<b>68,87</b>				
APX20200	M20x200	✓	M									

General parameters					Uncracked concrete		Cracked concrete	
					Tension	Shear	Tracción	Tension
Family	Code	Size	Family	Code	Size	Family	Code	Size
MTP-AT	APAT08075	M8x75	✓	C	9,00	<u>11,90</u>	5,00	<b>11,45</b>
	APAT08095	M8x95	✓	E				
	APAT08115	M8x115	✓	G				
	APAT10090	M10x90	✓	E	18,00	<u>20,30</u>	9,50	<u>20,30</u>
	APAT10105	M10x105	✓	F				
	APAT10115	M10x115	✓	G				
	APAT10135	M10x135	✓	H				
	APAT10165	M10x165	✓	K				
	APAT10185	M10x185	✓	L				
	APAT12100	M12x100	✓	E	20,00	<u>29,50</u>	12,00	<u>29,50</u>
	APAT12110	M12x110	✓	F				
	APAT12120	M12x120	✓	G				
	APAT12130	M12x130	✓	H				
	APAT12150	M12x150	✓	I				
	APAT12180	M12x180	✓	L				
	APAT12200	M12x200	✓	M				
	APAT16145	M16x145	✓	I	36,00	<u>54,90</u>	25,00	<b>53,97</b>
	APAT16175	M16x175	✓	K				
	APAT16220	M16x220	✓	O				
	APAT20170	M20x170	✓	K	48,00	<u>85,70</u>	32,00	<b>68,87</b>
APAT20200	M20x200	✓	M					

1 KN ≈ 100 kg  
 Values underlined and in italics show Steel failure, **bold** values concrete failure and other indicate pull out failure.

5.2 DESIGN RESISTANCE [kN]								
General parameters					Uncracked concrete		Cracked concrete	
					Tension	Shear	Tension	Shear
Family	Code	Size	Assessed	Letter on the head tip	N <sub>Rd</sub>	V <sub>Rd</sub>	N <sub>Rd</sub>	V <sub>Rd</sub>
MTP	AP08050	M8x50		A	2,51	<b>5,39</b>	1,79	<b>3,77</b>
	AP08075	M8x75	✓	C	5,00	<u>9,52</u>	2,78	<b>7,63</b>
	AP08095	M8x95	✓	E				
	AP08115	M8x115	✓	G				
	AP10090	M10x90	✓	E				
	AP10105	M10x105	✓	F	12,00	<u>16,24</u>	6,33	<u>16,24</u>
	AP10115	M10x115	✓	G				
	AP10135	M10x135	✓	H				
	AP10165	M10x165	✓	K				
	AP10185	M10x185	✓	L				
	AP12080	M12x80		D	8,04	<b>23,19</b>	5,73	<b>16,23</b>
	AP12100	M12x100	✓	E	13,33	<u>23,60</u>	8,00	<u>23,60</u>
	AP12110	M12x110	✓	F				
	AP12120	M12x120	✓	G				
	AP12130	M12x130	✓	H				
	AP12150	M12x150	✓	I				
	AP12180	M12x180	✓	L				
	AP12200	M12x200	✓	M	24,00	<u>43,92</u>	16,67	<b>35,98</b>
	AP16145	M16x145	✓	I				
	AP16175	M16x175	✓	K				
	AP16220	M16x220	✓	O				
	AP16250	M16x250	✓	Q	32,00	<u>65,59</u>	21,33	<b>45,91</b>
	AP20170	M20x170	✓	K				
AP20200	M20x200	✓	M	30,56	<u>67,76</u>	19,44	<b>64,17</b>	
AP24205	M24x205	✓	N					
AP24235	M24x235	✓	P					
MTP-G	APG06060	M6X60		B	3,33	<u>4,83</u>	--	--
	APG06070	M6X70		C				
	APG06100	M6X100		E				
	APG08050	M8x50		A	2,51	<b>5,39</b>	1,79	<b>3,77</b>
	APG08060	M8X60		B				
	APG08075	M8x75	✓	C	5,56	<u>9,52</u>	3,33	<b>7,63</b>
	APG08095	M8x95	✓	E				
	APG08115	M8x115	✓	G				
	APG10070	M10x70		C	4,47	<u>16,24</u>	3,18	<b>13,86</b>
	APG10090	M10x90	✓	E	12,00	<u>16,24</u>	6,67	<u>16,24</u>
	APG10105	M10x105	✓	F				
	APG10115	M10x115	✓	G				
	APG10135	M10x135	✓	H				
	APG10150	M10X150	✓	I				
	APG10165	M10x165	✓	K				
APG10185	M10x185	✓	L					

General parameters					Uncracked concrete		Cracked concrete					
					Tension	Shear	Tension	Shear				
Family	Code	Size	Assessed	Letter on the head tip	N <sub>Rk</sub>	V <sub>Rk</sub>	N <sub>Rk</sub>	V <sub>Rk</sub>				
MTP-G	APG12080	M12x80		D	8,04	23,19	5,73	16,23				
	APG12090	M12x90		E								
	APG12110	M12x110	✓	F	19,21	23,60	10,67	23,60				
	APG12130	M12x130	✓	H								
	APG12150	M12x150	✓	I								
	APG12160	M12x160	✓	J								
	APG12180	M12x180	✓	L								
	APG12200	M12x200	✓	M								
	APG16125	M16x125	✓	G								
	APG16145	M16x145	✓	I	24,00	43,92	17,99	35,98				
	APG16175	M16x175	✓	K								
	APG16220	M16x220	✓	O								
	APG16250	M16x250	✓	Q								
	APG20170	M20x170	✓	K								
	APG20200	M20x200	✓	M	32,80	65,59	20,00	45,91				
MTP-X	APX08050	M8x50		A	2,51	5,39	1,79	3,77				
	APX08075	M8x75	✓	C	5,56	9,52	3,89	7,63				
	APX08080	M8x80	✓	D								
	APX08095	M8x95	✓	E								
	APX08115	M8x115	✓	G								
	APX10090	M10x90	✓	E								
	APX10105	M10x105	✓	F	12,00	16,24	7,33	16,24				
	APX10115	M10x115	✓	G								
	APX10135	M10x135	✓	H								
	APX10165	M10x165	✓	K								
	APX10185	M10x185	✓	L								
	APX12080	M12x80		D					6,70	11,60	4,78	8,12
	APX12100	M12x100	✓	E					18,67	23,60	10,00	23,60
	APX12110	M12x110	✓	F								
	APX12120	M12x120	✓	G								
	APX12130	M12x130	✓	H								
	APX12150	M12x150	✓	I								
	APX12180	M12x180	✓	L								
	APX12200	M12x200	✓	M								
	APX12220	M12x220	✓	O								
	APX12255	M12x255	✓	R								
	APX16145	M16x145	✓	I	22,67	43,92	17,99	35,98				
	APX16175	M16x175	✓	K								
	APX16220	M16x220	✓	O								
	APX16250	M16x250	✓	Q								
APX20170	M20x170	✓	K									
APX20200	M20x200	✓	M	32,80	65,59	22,96	45,91					

General parameters					Uncracked concrete		Cracked concrete	
					Tension	Shear	Tracción	Tension
Family	Code	Size	Family	Code	Size	Family	Code	Size
MTP-AT	APAT08075	M8x75	✓	C	5,00	<u>9,52</u>	2,78	<b>7,63</b>
	APAT08095	M8x95	✓	E				
	APAT08115	M8x115	✓	G				
	APAT10090	M10x90	✓	E	12,00	<u>16,24</u>	6,33	<u>16,24</u>
	APAT10105	M10x105	✓	F				
	APAT10115	M10x115	✓	G				
	APAT10135	M10x135	✓	H				
	APAT10165	M10x165	✓	K				
	APAT10185	M10x185	✓	L				
	APAT12100	M12x100	✓	E	13,33	<u>23,60</u>	8,00	<u>23,60</u>
	APAT12110	M12x110	✓	F				
	APAT12120	M12x120	✓	G				
	APAT12130	M12x130	✓	H				
	APAT12150	M12x150	✓	I				
	APAT12180	M12x180	✓	L				
	APAT12200	M12x200	✓	M				
	APAT16145	M16x145	✓	I	24,00	<u>43,92</u>	16,67	<b>35,98</b>
	APAT16175	M16x175	✓	K				
	APAT16220	M16x220	✓	O				
	APAT20170	M20x170	✓	K	32,00	<u>65,59</u>	21,33	<b>45,91</b>
APAT20200	M20x200	✓	M					

1 KN ≈ 100 kg  
 Values underlined and in italics show Steel failure, **bold** values concrete failure and other indicate pull out failure

**5.3 MAXIMUM RECOMMENDED LOADS [kN] (con  $\gamma_F=1.4$ )**

General parameters					Uncracked concrete		Cracked concrete	
					Tension	Shear	Tension	Shear
Family	Code	Size	Assessed	Letter on the head tip	N <sub>rec</sub>	V <sub>rec</sub>	N <sub>rec</sub>	V <sub>rec</sub>
MTP	AP08050	M8x50		A	1,79	<b>3,85</b>	1,28	<b>2,69</b>
	AP08075	M8x75	✓	C	3,57	<u>6,80</u>	1,98	<b>5,45</b>
	AP08095	M8x95	✓	E				
	AP08115	M8x115	✓	G				
	AP10090	M10x90	✓	E				
	AP10105	M10x105	✓	F				
	AP10115	M10x115	✓	G				
	AP10135	M10x135	✓	H				
	AP10165	M10x165	✓	K	8,57	<u>11,60</u>	4,52	<u>11,60</u>
	AP10185	M10x185	✓	L				
	AP12080	M12x80		D				
	AP12100	M12x100	✓	E				
	AP12110	M12x110	✓	F				
	AP12120	M12x120	✓	G				
	AP12130	M12x130	✓	H				
	AP12150	M12x150	✓	I	9,52	<u>16,86</u>	5,71	<u>16,86</u>
	AP12180	M12x180	✓	L				
	AP12200	M12x200	✓	M				
	AP16145	M16x145	✓	I				
	AP16175	M16x175	✓	K				
	AP16220	M16x220	✓	O				
	AP16250	M16x250	✓	Q				
	AP20170	M20x170	✓	K	17,14	<u>31,37</u>	11,90	<b>25,70</b>
AP20200	M20x200	✓	M					
AP24205	M24x205	✓	N					
AP24235	M24x235	✓	P	21,83	<u>48,40</u>	13,89	<b>48,83</b>	
MTP-G	APG06060	M6X60		B	2,38	<u>3,45</u>	--	--
	APG06070	M6X70		C				
	APG06100	M6X100		E				
	APG08050	M8x50		A	3,97	<u>6,80</u>	2,38	<b>5,45</b>
	APG08060	M8X60		B				
	APG08075	M8x75	✓	C				
	APG08095	M8x95	✓	E				
	APG08115	M8x115	✓	G	3,19	<u>11,60</u>	2,27	<b>9,90</b>
	APG10070	M10x70		C				
	APG10090	M10x90	✓	E				
	APG10105	M10x105	✓	F				
	APG10115	M10x115	✓	G				
	APG10135	M10x135	✓	H				
	APG10150	M10X150	✓	I				
	APG10165	M10x165	✓	K				
	APG10185	M10x185	✓	L	8,57	<u>11,60</u>	4,76	<u>11,60</u>

General parameters					Uncracked concrete		Cracked concrete					
					Tension	Shear	Tension	Shear				
Family	Code	Size	Assessed	Letter on the head tip	N <sub>rec</sub>	V <sub>rec</sub>	N <sub>rec</sub>	V <sub>rec</sub>				
MTP-G	APG12080	M12x80		D	5,74	16,56	4,09	11,60				
	APG12090	M12x90		E								
	APG12110	M12x110	✓	F	13,72	16,86	7,62	16,86				
	APG12130	M12x130	✓	H								
	APG12150	M12x150	✓	I								
	APG12160	M12x160	✓	J								
	APG12180	M12x180	✓	L								
	APG12200	M12x200	✓	M								
	APG16125	M16x125	✓	G	17,14	31,37	12,85	25,70				
	APG16145	M16x145	✓	I								
	APG16175	M16x175	✓	K								
	APG16220	M16x220	✓	O								
	APG16250	M16x250	✓	Q								
	APG20170	M20x170	✓	K								
	APG20200	M20x200	✓	M	23,43	46,85	14,29	32,80				
MTP-X	APX08050	M8x50		A	1,79	3,85	1,28	2,69				
	APX08075	M8x75	✓	C	3,97	6,80	2,78	5,45				
	APX08080	M8x80	✓	D								
	APX08095	M8x95	✓	E								
	APX08115	M8x115	✓	G								
	APX10090	M10x90	✓	E								
	APX10105	M10x105	✓	F	8,57	11,60	5,24	11,60				
	APX10115	M10x115	✓	G								
	APX10135	M10x135	✓	H								
	APX10165	M10x165	✓	K								
	APX10185	M10x185	✓	L								
	APX12080	M12x80		D					4,79	8,28	3,41	5,80
	APX12100	M12x100	✓	E	13,33	16,86	7,14	16,86				
	APX12110	M12x110	✓	F								
	APX12120	M12x120	✓	G								
	APX12130	M12x130	✓	H								
	APX12150	M12x150	✓	I								
	APX12180	M12x180	✓	L								
	APX12200	M12x200	✓	M								
	APX12220	M12x220	✓	O								
	APX12255	M12x255	✓	R								
	APX16145	M16x145	✓	I					16,19	31,37	12,85	25,70
	APX16175	M16x175	✓	K								
	APX16220	M16x220	✓	O								
	APX16250	M16x250	✓	Q								
	APX20170	M20x170	✓	K	23,43	46,85	16,40	32,80				
	APX20200	M20x200	✓	M								

General parameters					Uncracked concrete		Cracked concrete	
					Tension	Shear	Tracción	Tension
Family	Code	Size	Family	Code	Size	Family	Code	Size
MTP-AT	APAT08075	M8x75	✓	C	3,57	<u>6,80</u>	1,98	<b>5,45</b>
	APAT08095	M8x95	✓	E				
	APAT08115	M8x115	✓	G				
	APAT10090	M10x90	✓	E	8,57	<u>11,60</u>	4,52	<u>11,60</u>
	APAT10105	M10x105	✓	F				
	APAT10115	M10x115	✓	G				
	APAT10135	M10x135	✓	H				
	APAT10165	M10x165	✓	K				
	APAT10185	M10x185	✓	L				
	APAT12100	M12x100	✓	E	9,52	<u>16,86</u>	5,71	<u>16,86</u>
	APAT12110	M12x110	✓	F				
	APAT12120	M12x120	✓	G				
	APAT12130	M12x130	✓	H				
	APAT12150	M12x150	✓	I				
	APAT12180	M12x180	✓	L				
	APAT12200	M12x200	✓	M				
	APAT16145	M16x145	✓	I	17,14	<u>31,37</u>	11,90	<b>25,70</b>
	APAT16175	M16x175	✓	K				
	APAT16220	M16x220	✓	O				
	APAT20170	M20x170	✓	K	22,86	<u>46,85</u>	15,24	<b>32,80</b>
APAT20200	M20x200	✓	M					

1 KN ≈ 100 kg  
 Values underlined and in italics show Steel failure, **bold** values concrete failure and other indicate pull out failure..

**5.4 INCREASING FACTORS FOR TENSION LOADS IN HIGH RESISTANCE CONCRETE**

SIZE		M6	M8	M10	M12	M16	M20	M24	
$\psi_c$	$N^0_{Rk,p}$	C30/37	--	1,22	1,17	1,22	1,22	1,17	1,22
		C40/50	--	1,41	1,31	1,41	1,41	1,31	1,41
		C50/60	--	1,58	1,43	1,58	1,58	1,43	1,58

**5.5 INTENDED USE**

SIZE		M8	M10	M12	M16	M20	M24
<b>MTP</b>	Static or quasi-static loads	✓	✓	✓	✓	✓	✓
	Seismic loads, category C1		✓	✓	✓		
	Seismic loads, category C2			✓	✓		
	Fire exposure resistance	✓	✓	✓	✓	✓	✓
<b>MTP-G</b>	Static or quasi-static loads	✓	✓	✓	✓	✓	✓
	Seismic loads, category C1	✓	✓	✓	✓	✓	✓
	Seismic loads, category C2			✓	✓	✓	
	Fire exposure resistance	✓	✓	✓	✓	✓	✓
<b>MTP-X</b>	Static or quasi-static loads	✓	✓	✓	✓	✓	✓
	Seismic loads, category C1	✓	✓	✓	✓	✓	✓
	Seismic loads, category C2		✓	✓		✓	
	Fire exposure resistance	✓	✓	✓	✓	✓	✓
<b>MTP-AT</b>	Static or quasi-static loads	✓	✓	✓	✓	✓	✓
	Seismic loads, category C1		✓	✓	✓		
	Seismic loads, category C2			✓	✓		
	Fire exposure resistance	✓	✓	✓	✓	✓	✓

**6. OFFICIAL DOCUMENTATION**

The following documents are available through our sales Department or on our official website:  
[www.indexfix.com](http://www.indexfix.com)

- European Technical Assesment ETA-12/0397 for use in concrete, according to EAD 330232-01-0601, option 1, from M8 to M24.
- Declaration of Performances DoP MTP-en
- Certificate VdS CEA 4001:2021-01(07) Guidelines for sprinklers systems. Planning and installation for applications of water extinguishing systems on concrete elements from M8 to M20.
- Certificate FM Pipe Hanger Components for Automatic Sprinkler Systems for MTP-X from M10 to M16.
- Available for anchor calculation program INDEXcal.