

KC-PSA

PRODUCT DESCRIPTION

Coplanar kit with winged aluminium profile (PSA-A). Direct fixing



ASSESSMENTS



CHARACTERISTICS

- Assembly kit containing the components necessary for the installation of a determined number of solar panels.
- Installation based on **SC-PSA** coplanar mounting system.
- Includes quick fixing clamps **KFRSC3050** for panels.
- Includes **GM-A** gauges for heights of 30, 35 and 40 mm.
- Includes **PSA-A** aluminium profile structure in continuous format.
- Includes **PSAUN200** profile joint with **DIN-7504-K A2** installation screw set.

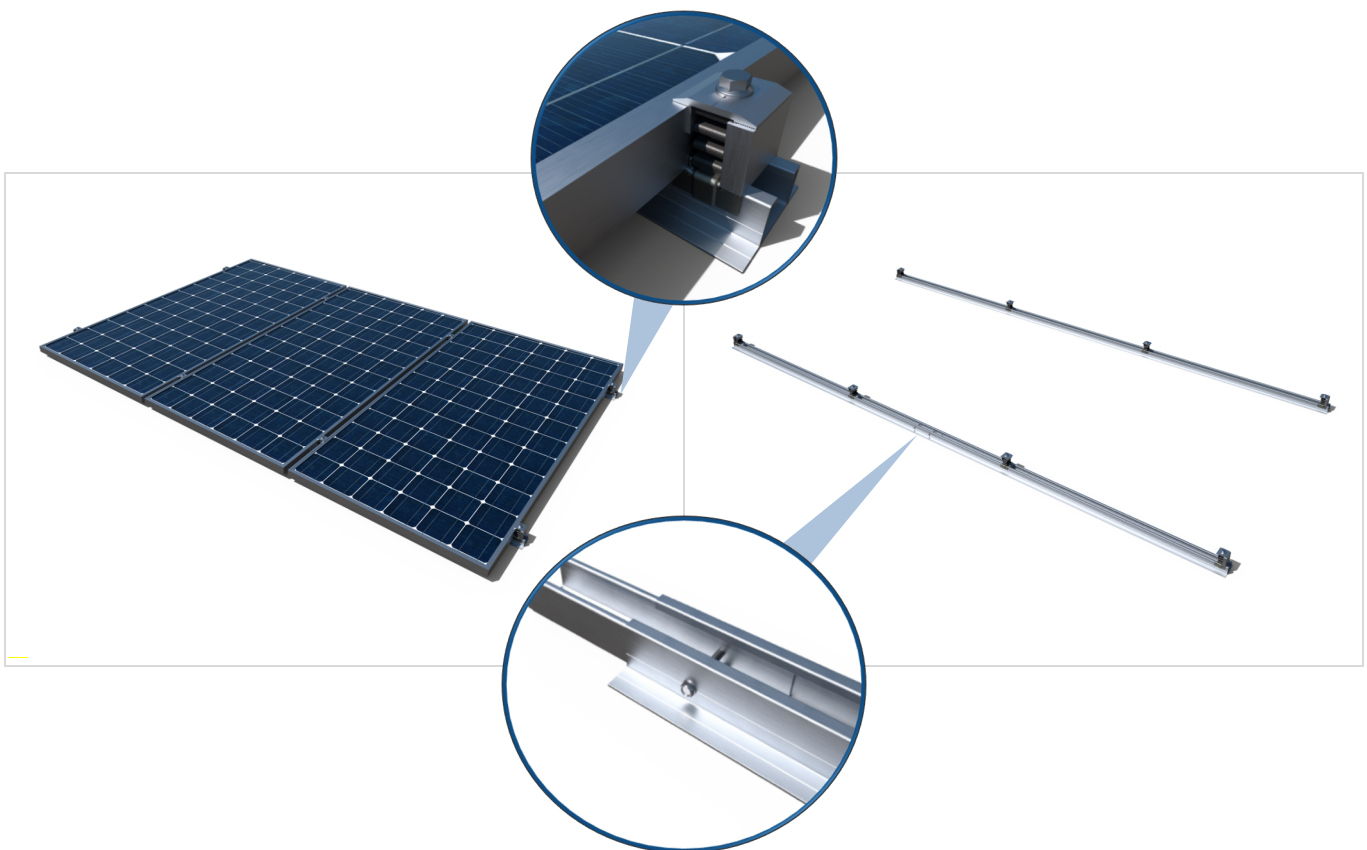

COMPONENTS

Quick pre-assembled clamp

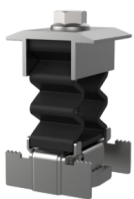

KFR-SC

Aluminium gauge for solar frame

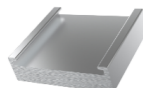

GM-A

Winged aluminium profile

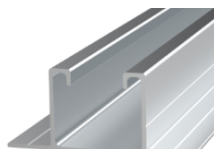

PSA-A

Winged aluminium profile connector

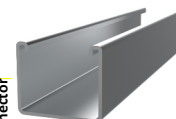

PSA-UN

A2 DIN-7504-K bolt













ABE-I

APPLICATIONS

- Assembly of solar panels in parallel with respect to the roof surface on sloping roofs.
- Installation on metal roofs on the upper face of the ribs.
- For panels with 30, 35 or 40 mm-high frames.
- For panels sizes up to 1150 mm wide
- Portrait view (vertical) orientation panel assembly with profiles mounted perpendicular to the slope line.
- Direct fixing kit for roof mounting. Consult specifications in the SC-PSA mounting system technical data sheet.







1.RANGE

| ITEM | CODE | PHOTO | DESCRIPTION | PANELS | FRAME | LENGTH ROW | MATERIAL | | |
|------|-----------|---|---|--------|-------|------------|--|---|---|
| 1 | KCPSA0230 |  | Coplanar kit with winged aluminium profile (PSA-A). Direct fixing. For two panels | 2 | 30 mm | 2500 mm |  Aluminium |  AISI-304 |  EPDM |
| | KCPSA0235 | | | 2 | 35 mm | 2500 mm | | | |
| | KCPSA0240 | | | 2 | 40 mm | 2500 mm | | | |
| 2 | KCPSA0330 |  | Coplanar kit with winged aluminium profile (PSA-A). Direct fixing. For three panels | 3 | 30 mm | 3750 mm |  Aluminium |  AISI-304 |  EPDM |
| | KCPSA0335 | | | 3 | 35 mm | 3750 mm | | | |
| | KCPSA0340 | | | 3 | 40 mm | 3750 mm | | | |
| 3 | KCPSA02AM |  | Coplanar extension kit with winged profile Aluminium (PSA-A). Direct fixing. For 2 panels | 2 | -- | 2500 mm |  Aluminium |  AISI-304 |  EPDM |
| | KCPSA03AM | | | 3 | -- | 3750 mm | | | |

2.INSTALLATION DATA

2.1 KCPSA02

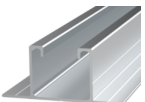
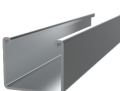
Coplanar kit with winged aluminium profile (PSA-A). Direct fixing. For two panels

|  |  2 panels Reference | Components Kit | | | | |
|---|--|---|--|---|---|---|
| | |  Quick, pre-assembled clamp |  Aluminium gauge for solar frame |  Winged aluminium profile |  Winged aluminium profile |  A2 DIN-7504-K bolt |
| KCPSA0230 (H=30mm) | KFRSC3050 6 units | GMA030 4 units | PSAA1250 4 units | PSAUN200 2 units | ABEI5519 8 units | |
| KCPSA0235 (H=35mm) | KFRSC3050 6 units | GMA035 4 units | PSAA1250 4 units | PSAUN200 2 units | ABEI5519 8 units | |
| KCPSA0240 (H=40mm) | KFRSC3050 6 units | GMA040 4 units | PSAA1250 4 units | PSAUN200 2 units | ABEI5519 8 units | |

Roof/Fixing accessories

Consult technical data sheet corresponding to the SC-PSA assembly system.

Measurement table



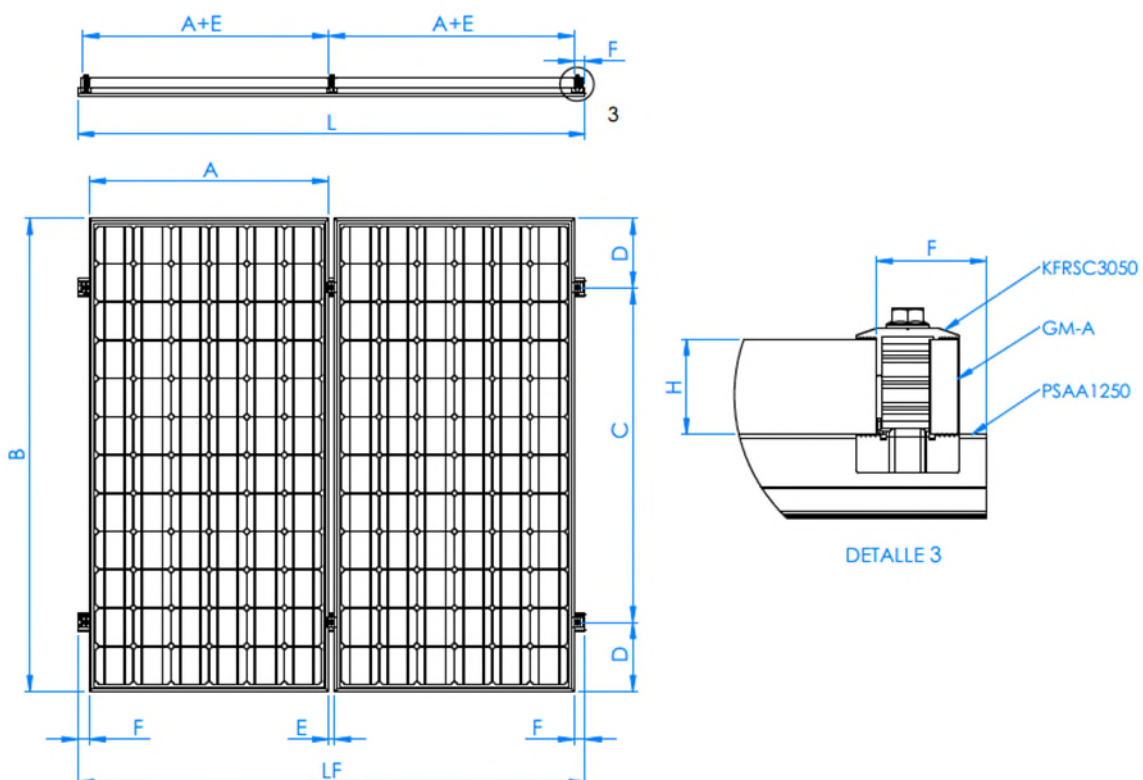

| Code | A (mm) | B (mm) | C (mm) | D (mm) | E (mm) | F (mm) | H (mm) | L (mm) | LF (mm) |
|-----------|-----------|-----------|-------------|-----------|-----------|-----------|-----------|-----------|------------|
| KCPSA0230 | ≤ 1150 | ≤ 2300 | 0,5B ÷ 0,7B | (B-C) / 2 | 26 | ≥ 35 | 30 | 2500 | 2500 |
| KCPSA0235 | ≤ 1150 | ≤ 2300 | 0,5B ÷ 0,7B | (B-C) / 2 | 26 | ≥ 35 | 35 | 2500 | 2500 |
| KCPSA0240 | ≤ 1150 | ≤ 2300 | 0,5B ÷ 0,7B | (B-C) / 2 | 26 | ≥ 35 | 40 | 2500 | 2500 |

Drawing

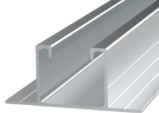
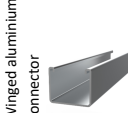

2.2 KCPSA03

Coplanar kit with winged aluminium profile (PSA-A). Direct fixing. For three panels

| | | | | | | |
|---|--|--|---|---|---|--|
|  | Components Kit | | | | | |
| |  Quick pre-assembled clamp |  Aluminium gauge for solar frame |  Winged aluminium profile |  Winged aluminium profile connector |  A2 DIN-7504-K bolt | |
| | 3 panels | | | | | |
| | Reference | | | | | |
| KCPSA0330 (H=30mm) | KFRSC3050 8 units | GMA030 4 units | PSAA1875 4 units | PSAUN200 2 units | ABE15519 8 units | |
| KCPSA0335 (H=35mm) | KFRSC3050 8 units | GMA035 4 units | PSAA1875 4 units | PSAUN200 2 units | ABE15519 8 units | |
| KCPSA0340 (H=40mm) | KFRSC3050 8 units | GMA040 4 units | PSAA1875 4 units | PSAUN200 2 units | ABE15519 8 units | |

Roof/Fixing accessories

Consult technical data sheet corresponding to the SC-PSA assembly system.

Measurement table



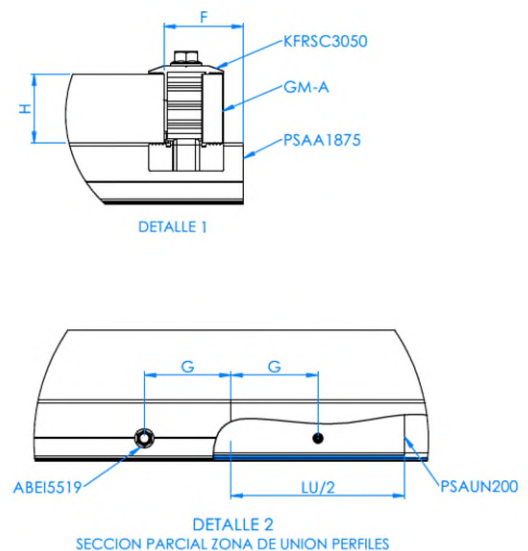
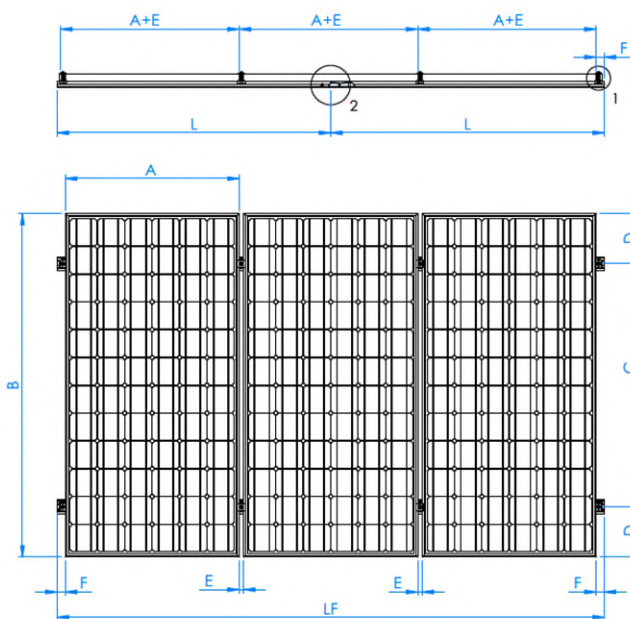

| Code | A (mm) | B (mm) | C (mm) | D (mm) | E (mm) | F (mm) | G (mm) | H (mm) | L (mm) | LF (mm) | LU/2 (mm) |
|-----------|--------|--------|-------------|-----------|--------|--------|--------|--------|--------|---------|-----------|
| KCPSA0330 | ≤ 1150 | ≤ 2300 | 0,5B ÷ 0,7B | (B-C) / 2 | 26 | ≥ 35 | 50÷70 | 30 | 1875 | 3750 | 100 |
| KCPSA0335 | ≤ 1150 | ≤ 2300 | 0,5B ÷ 0,7B | (B-C) / 2 | 26 | ≥ 35 | 50÷70 | 35 | 1875 | 3750 | 100 |
| KCPSA0340 | ≤ 1150 | ≤ 2300 | 0,5B ÷ 0,7B | (B-C) / 2 | 26 | ≥ 35 | 50÷70 | 40 | 1875 | 3750 | 100 |

Drawing

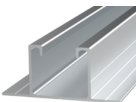
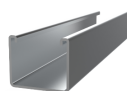

2.3 KCPSA-AM

Coplanar extension kit with winged profile Aluminium (PSA-A). Direct fixing. For 2 and 3 panels

|  | Components Kit | | | |
|---|---|--|---|---|
| | Quick pre-assembled clamp | Winged aluminium profile | Winged aluminium profile | A2 DIN-7504-K bolt |
| 2 & 3 panels |  |  |  |  |
| Reference | | | | |
| KCPSA02AM | KFRSC3050 4 units | PSAA1250 4 units | PSAUN200 4 units | ABEI5519 16 units |
| KCPSA03AM | KFRSC3050 6 units | PSAA1875 4 units | PSAUN200 4 units | ABEI5519 16 units |

Roof/Fixing accessories

Consult technical data sheet corresponding to the SC-PSA assembly system.

Measurement table

| Code | A (mm) | B (mm) | C (mm) | D (mm) | E (mm) | F (mm) | G (mm) | L (mm) | LF (mm) | LU/2 (mm) |
|-----------|--------|--------|-------------|-----------|--------|--------|--------|--------|---------|-----------|
| KCPSA02AM | ≤ 1150 | ≤ 2300 | 0,5B ÷ 0,7B | (B-C) / 2 | 26 | ≥ 35 | 50÷70 | 1250 | 2500 | 100 |
| KCPSA03AM | ≤ 1150 | ≤ 2300 | 0,5B ÷ 0,7B | (B-C) / 2 | 26 | ≥ 35 | 50÷70 | 1875 | 3750 | 100 |

Drawing

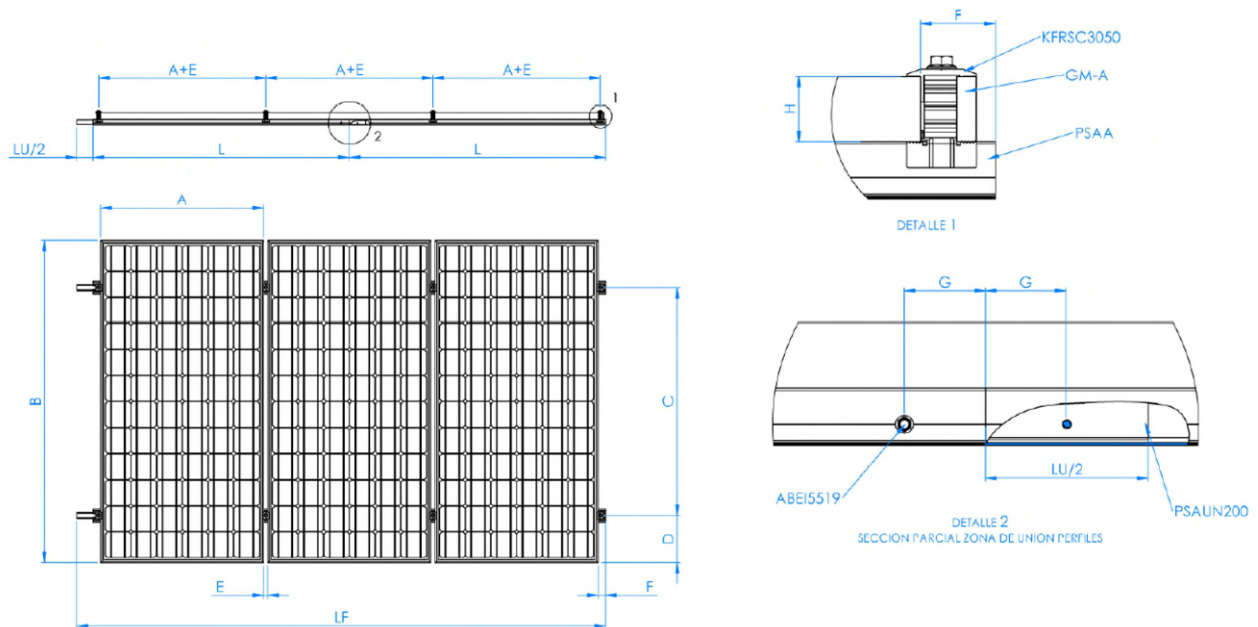

Example of composition kit expansion 3 pannels