



Direct fixing concrete screw, for use in cracked and non cracked concrete

TFE

Assessed ETA Option 1 for structural use and ETA assessed for non structural use. Steel with zinc plated coating.



PRODUCT INFORMATION

DESCRIPTION

Metallic screw, with thread for fixing in cracked and non-cracked concrete.

OFFICIAL DOCUMENTATION

- CE-1219-CPR-0261.
- CE-1219-CPR-0254.
- ETA 20/0046 option 1.
- ETA 20/0494 for use in concrete and hollow core slabs for redundant non-structural systems.
- Declaration of Performance DoP THE.

SIZES

Ø5x40(5) to Ø18x200(18).

DESIGN LOAD RANGE

From 2,78 to 38,7 kN [non-cracked].
From 2,54 to 27,21 kN [cracked].



BASE MATERIAL

Concrete class C20/25 to C50/60 cracked or non-cracked.



Stone

Concrete

Reinforced Concrete

Cracked Concrete

ASSESSMENTS

- Option 1 [Cracked and non cracked concrete].
- Multiple use.
- Fire Resistance R30-120.
- Seismic C1 Ø6÷Ø18.
- Seismic C2 Ø8÷Ø18.
- VdS Certificate CEA 4001.



20
Técnicas Expansivas S.L.
Segador 13. Logroño. Spain
ETA 20/0046, ETA 20/0494
1219
Structural / non structural
fixings in concrete



CHARACTERISTICS AND BENEFITS

- Easy installation
- Use in cracked and non-cracked concrete.
- Use for medium-heavy duty loads.
- Several versions with different heads / coatings (see full range).
- Variety of length and diameters: flexibility in assembly
- Suitable when reduced distance to edge and between anchors is required.
- Working by mechanical interlock between concrete and thread.
- For static and quasi static loads and seismic.
- Direct fixing; no wrench needed.
- Can be uninstalled leaving the surface clear. [Reusable].
- Available at INDEXcal.



MATERIALS

Screw: Carbon steel; zinc plated coating.



APPLICATIONS

- Structural fixings cracked and non cracked concrete, including industrial and marine environments.
- Glazing, windows and shop windows.
- Industrial racks.
- Installation of railings and handrails in interiors.
- Fixation of steel structures, canals, machinery, boilers, signs, stadium seats, facade substructures, etc.
- Fixing of wood structures in concrete.

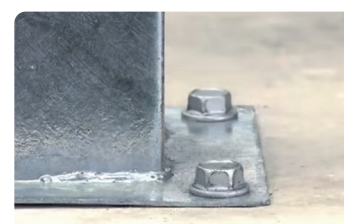



MECHANICAL PROPERTIES

			Ø6	Ø8	Ø10	Ø12	Ø14	Ø18
Threaded area section								
A_s	(mm ²)	Threaded area section	26,0	45,3	71,2	100,6	149,6	237,2
$F_{u,s}$	(N/mm ²)	Characteristic tension resistance	965	865	770	740	705	681
$F_{y,s}$	(N/mm ²)	Yield strength	869	779	693	666	635	613

INSTALLATION DATA

SIZE		Ø6	Ø8	Ø10	Ø12	Ø14	Ø18							
Code		TFX06XXX	TFX08XXX	TFX10XXX	TFX12XXX	TFX14XXX	TFX18XXX							
		h_{ef1} h_{ef3}	h_{ef1} h_{ef3}	h_{ef1} h_{ef2} h_{ef3}	h_{ef1} h_{ef3}	h_{ef1} h_{ef3}	h_{ef1} h_{ef3}							
d_0	Drill diameter [mm]	6	8	10	12	14	18							
T_{ins}	Recommended torque ≤ [Nm]	10	20	30	50	70	90							
d_f	Fixture diameter [mm]	9	12	14	16	18	22							
h_1	Minimum drill depth [mm]	45 65	60 75	65 85 95	90 120	90 130	110 160							
h_{nom}	Embedment depth [mm]	35 55	50 65	55 75 85	75 105	75 115	90 140							
h_{ef}	Min. effective depth [mm]	26 43	37,5 50,5	41,5 58,5 67	58 83,5	58 92	69,5 112							
h_{min}	Base material minimum thickness [mm]	100	100	100	120	135	120 170 120 185 140 225							
t_{fix}	Maximum fixture thickness [mm]	L-35	L-55	L-50	L-65	L-55	L-75	L-85	L-75	L-105	L-75	L-115	L-90	L-140
$S_{cr,N}$	Critical spacing [mm]	78	129	113	151,5	125	175,5	201	174	250,5	174	276	208,5	336
$C_{cr,N}$	Critical edge distance [mm]	39	64,5	56,5	75,75	62,5	87,75	100,5	87	125,25	87	138	104,5	168
$S_{cr,sp}$	Critical spacing to cracking [mm]	90	170	130	200	140	190	210	190	220	190	230	230	350
$C_{cr,sp}$	Critical edge distance to cracking [mm]	45	85	65	100	70	95	105	95	110	95	115	115	175
S_{min}	Minimum spacing [mm]	35	35	35	35	50	50	50	75	75	80	80	90	90
C_{min}	Minimum edge distance [mm]	35	35	35	35	40	40	40	45	45	50	50	55	55
SW	Installation wrench	10	13	15	15	15	15	15	18	18	21	21	24	24

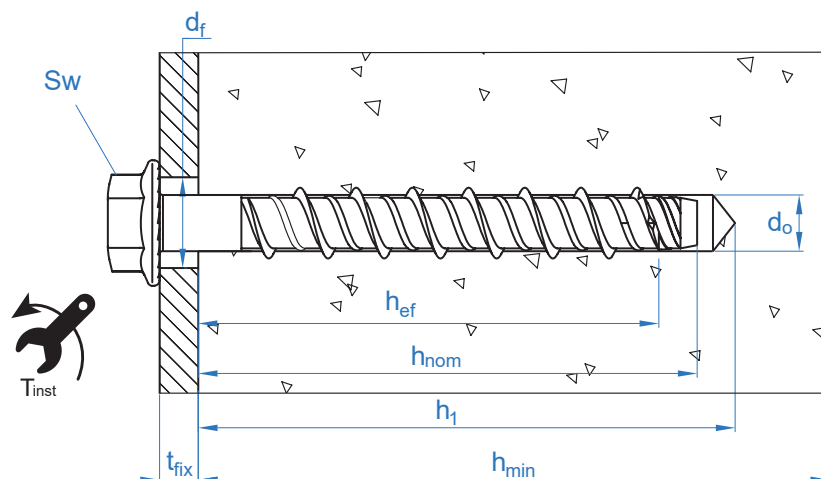



Code	INSTALLATION PRODUCTS
	Hammer drill
BHDSXXXXX	Concrete Drill bits
MOBOMBA	Blow pump
MORCEPKIT	Cleaning Brush
	Impact wrench
	Hexagonal socket

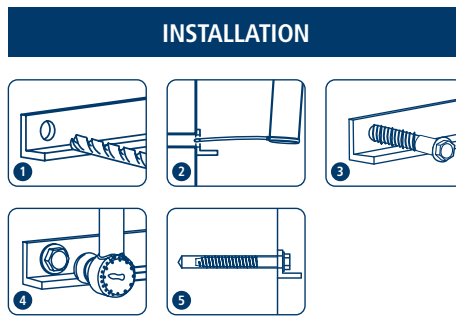

TFE

Resistances in C20/25 concrete for an isolated anchor, without effects of edge distance or spacing

Characteristic Resistance																		
TENSION								SHEAR										
Size		Ø6	Ø8	Ø10	Ø12	Ø14	Ø18	Size		Ø6	Ø8	Ø10	Ø12	Ø14	Ø18			
N _{Rk}	Non-cracked concrete	h _{ef3}	13,90	17,70	27,00	37,50	43,40	58,31	V _{Rk}	Non-cracked concrete	h _{ef3}	12,53	19,57	27,40	37,24	52,72	80,78	
		h _{ef2}	-	-	22,00	-	-	-			h _{ef2}	-	-	27,40	-	-	-	-
		h _{ef1}	5,00	11,30	13,15	21,70	21,70	28,50			h _{ef1}	12,53	19,57	25,65	37,24	52,72	75,82	
N _{Rk}	Cracked concrete	h _{ef3}	9,70	12,40	18,90	26,30	30,40	40,82	V _{Rk}	Cracked concrete	h _{ef3}	11,17	15,69	27,40	37,24	52,72	80,78	
		h _{ef2}	-	-	15,40	-	-	-			h _{ef2}	-	-	20,34	-	-	-	
		h _{ef1}	4,60	7,90	9,20	15,20	15,20	20,00			h _{ef1}	9,36	14,23	17,95	35,44	38,79	53,07	

Design Resistance																	
TENSION								SHEAR									
Size		Ø6	Ø8	Ø10	Ø12	Ø14	Ø18	Size		Ø6	Ø8	Ø10	Ø12	Ø14	Ø18		
N _{Rd}	Non-cracked concrete	h _{ef3}	9,25	11,77	17,99	25,02	28,94	38,87	V _{Rd}	Non-cracked concrete	h _{ef3}	8,35	13,05	18,27	24,83	35,15	53,85
		h _{ef2}	-	-	14,67	-	-	-			h _{ef2}	-	-	18,27	-	-	-
		h _{ef1}	2,78	6,28	8,77	14,49	14,49	19,00			h _{ef1}	8,35	13,05	17,10	24,83	35,15	50,54
N _{Rd}	Cracked concrete	h _{ef3}	6,47	8,24	12,59	17,52	20,26	27,21	V _{Rd}	Cracked concrete	h _{ef3}	7,44	10,46	18,27	24,83	35,15	53,85
		h _{ef2}	-	-	10,27	-	-	-			h _{ef2}	-	-	13,56	-	-	-
		h _{ef1}	2,54	4,39	6,14	10,14	10,14	13,30			h _{ef1}	6,24	9,49	11,97	23,63	25,86	35,38

Maximum Loads Recommended																	
TENSION								SHEAR									
Size		Ø6	Ø8	Ø10	Ø12	Ø14	Ø18	Size		Ø6	Ø8	Ø10	Ø12	Ø14	Ø18		
N _{rec}	Non-cracked concrete	h _{ef3}	6,61	8,41	12,85	17,87	20,67	27,77	V _{rec}	Non-cracked concrete	h _{ef3}	5,97	9,32	12,21	17,73	25,10	36,10
		h _{ef2}	-	-	10,48	-	-	-			h _{ef2}	-	-	13,05	-	-	-
		h _{ef1}	1,98	4,48	6,26	10,35	10,35	13,57			h _{ef1}	5,97	9,32	13,05	17,73	25,10	38,47
N _{rec}	Cracked concrete	h _{ef3}	4,62	5,88	8,99	12,51	14,47	19,44	V _{rec}	Cracked concrete	h _{ef3}	5,32	7,47	13,05	17,73	25,10	38,47
		h _{ef2}	-	-	7,34	-	-	-			h _{ef2}	-	-	9,68	-	-	-
		h _{ef1}	1,81	3,14	4,38	7,24	7,24	9,50			h _{ef1}	4,46	6,78	8,55	16,88	18,47	25,27

Simplified calculation method. European Technical Assessment ETA 20/0046

Simplified version of the calculation method according to Eurocode 2 EN 1992-4. Resistance is calculated according to the data shown in assessment 20/0046.

- Influence of concrete strength.
- Influence of edge distance.
- Influence of spacing between anchors.
- Influence of reinforcements.
- Influence of base material thickness.
- Influence of load application angle.
- Valid for a group of two anchors.

The calculation method is based on the following simplification: **Different loads do not act on individual anchors, without eccentricity.**



INDEXcal

For a more accurate calculation and to take more constructive provisions into account, we recommend using our calculation program INDEXcal. It may be easily downloaded from our website www.indexfix.com



TFE

TENSION LOADS

- Steel design resistance: $N_{Rd,s}$
- Pull-out design resistance: $N_{Rd,p} = N_{Rd,p}^o \cdot \psi_c$
- Concrete cone design resistance: $N_{Rd,c} = N_{Rd,c}^o \cdot \psi_b \cdot \psi_{s,N} \cdot \psi_{c,N} \cdot \psi_{re,N}$
- Concrete splitting design resistance: $N_{Rd,sp} = N_{Rd,c}^o \cdot \psi_b \cdot \psi_{s,sp} \cdot \psi_{c,sp} \cdot \psi_{re,N} \cdot \psi_{h,sp}$

Steel Design resistance								
$N_{Rd,s}$								
Size			Ø6	Ø8	Ø10	Ø12	Ø14	Ø18
N_{Rd}^o	Non-cracked concrete	h_{ef3}	17,94	27,96	39,15	53,20	75,32	115,40
		h_{ef2}	-	-	39,15	-	-	-
		h_{ef1}	17,94	27,96	39,15	53,20	75,32	115,40
N_{Rd}^o	Cracked concrete	h_{ef3}	17,94	27,96	39,15	53,20	75,32	115,40
		h_{ef2}	-	-	39,15	-	-	-
		h_{ef1}	17,94	27,96	39,15	53,20	75,32	115,40

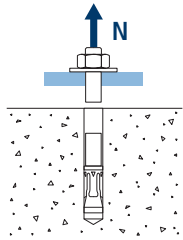

Pull-out design resistance								
$N_{Rd,p} = N_{Rd,p}^o \cdot \psi_c$								
Size			Ø6	Ø8	Ø10	Ø12	Ø14	Ø18
$N_{Rd,p}^o$	Non-cracked concrete	h_{ef3}	_*	_*	_*	_*	_*	_*
		h_{ef2}	-	-	_*	-	-	-
		h_{ef1}	2,78	_*	_*	_*	_*	_*
$N_{Rd,p}^o$	Cracked concrete	h_{ef3}	_*	_*	_*	_*	_*	_*
		h_{ef2}	-	-	_*	-	-	-
		h_{ef1}	_*	_*	_*	_*	_*	_*

* Pull-out failure is not decisive.

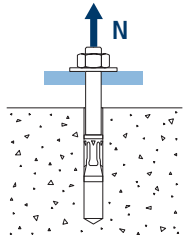

Concrete cone design resistance								
$N_{Rd,c} = N_{Rd,c}^o \cdot \psi_b \cdot \psi_{s,N} \cdot \psi_{c,N} \cdot \psi_{re,N}$								
Concrete cone design resistance								
$N_{Rd,sp} = N_{Rd,c}^o \cdot \psi_b \cdot \psi_{s,sp} \cdot \psi_{c,sp} \cdot \psi_{re,N} \cdot \psi_{h,sp}$								
Size			Ø6	Ø8	Ø10	Ø12	Ø14	Ø18
$N_{Rd,c}^o$	Non-cracked concrete	h_{ef3}	9,25	11,77	17,99	25,02	28,94	38,87
		h_{ef2}	-	-	14,67	-	-	-
		h_{ef1}	3,62	6,28	8,77	14,49	14,49	19,00
$N_{Rd,c}^o$	Cracked concrete	h_{ef3}	6,47	8,24	12,59	17,52	20,26	27,21
		h_{ef2}	-	-	10,27	-	-	-
		h_{ef1}	2,54	4,39	6,14	10,14	10,14	13,30

*Concrete splitting design resistance must only be considered for non-cracked concrete.

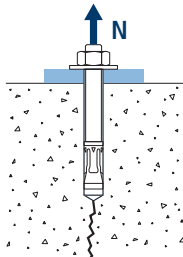
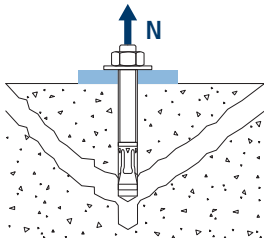



TFE

Coeficientes de influencia

Influence of concrete strength resistance in pul-out failure ψ_c

			Ø6	Ø8	Ø10	Ø12	Ø14	Ø18
ψ_c	h_{ef3}	C 20/25	1,00					
		C 30/37	1,22	1,22	1,22	1,22	1,20	1,17
		C 40/50	1,41	1,41	1,41	1,41	1,37	1,32
		C 50/60	1,58	1,58	1,58	1,58	1,51	1,42
	h_{ef2}	C 20/25	1,00					
		C 30/37	-	-	1,17	-	-	-
		C 40/50	-	-	1,30	-	-	-
		C 50/60	-	-	1,42	-	-	-
	h_{ef1}	C 20/25	1,00					
		C 30/37	1,16	1,21	1,22	1,16	1,21	1,22
		C 40/50	1,28	1,39	1,41	1,29	1,39	1,40
		C 50/60	1,39	1,54	1,58	1,40	1,55	1,57

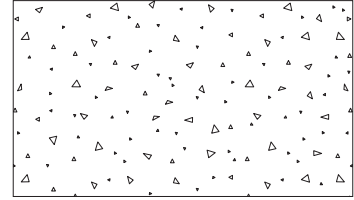
Influence of concrete strength in concrete cone and splitting failure ψ_b

			Ø6	Ø8	Ø10	Ø12	Ø14	Ø18
ψ_b	C 20/25	1,00						
	C 30/37	1,22						
	C 40/50	1,41						
	C 50/60	1,58						

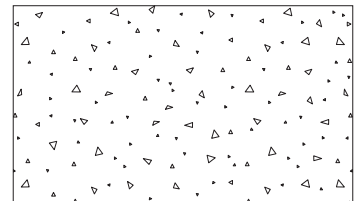

$$\psi_b = \sqrt{\frac{f_{ck, cube}}{25}} \geq 1$$



TFE



$$\psi_{s,N} = 0,5 + \frac{s}{2 \cdot s_{cr,N}} \leq 1$$

Influence of spacing (concrete cone) $\psi_{s,N}$													
s [mm]	TFE												
	Ø6		Ø8		Ø10			Ø12		Ø14		Ø18	
	h_{ef1}	h_{ef3}	h_{ef1}	h_{ef3}	h_{ef1}	h_{ef2}	h_{ef3}	h_{ef1}	h_{ef3}	h_{ef1}	h_{ef3}	h_{ef1}	h_{ef3}
35	0,72	0,64	0,66	0,62									
40	0,76	0,66	0,68	0,63									
50	0,82	0,69	0,72	0,67	0,70	0,64	0,62						
60	0,88	0,73	0,77	0,70	0,74	0,67	0,65						
70	0,95	0,77	0,81	0,73	0,78	0,70	0,67						
75	0,98	0,79	0,83	0,75	0,80	0,71	0,69	0,72	0,65				
78	1,00	0,80	0,85	0,76	0,81	0,72	0,69	0,72	0,66				
80		0,81	0,86	0,76	0,82	0,73	0,70	0,73	0,66	0,73	0,64		
90		0,85	0,90	0,80	0,86	0,76	0,72	0,76	0,68	0,76	0,66	0,72	0,63
100		0,89	0,94	0,83	0,90	0,78	0,75	0,79	0,70	0,79	0,68	0,74	0,65
110		0,93	0,99	0,86	0,94	0,81	0,77	0,82	0,72	0,82	0,70	0,76	0,66
113		0,94	1,00	0,87	0,95	0,82	0,78	0,82	0,73	0,82	0,70	0,77	0,67
120		0,97		0,90	0,98	0,84	0,80	0,84	0,74	0,84	0,72	0,79	0,68
125		0,98		0,91	1,00	0,86	0,81	0,86	0,75	0,86	0,73	0,80	0,69
130		1,00		0,93		0,87	0,82	0,87	0,76	0,87	0,74	0,81	0,69
140				0,96		0,90	0,85	0,90	0,78	0,90	0,75	0,84	0,71
150				1,00		0,93	0,87	0,93	0,80	0,93	0,77	0,86	0,72
152				1,00		0,93	0,88	0,94	0,80	0,94	0,78	0,86	0,73
160						0,96	0,90	0,96	0,82	0,96	0,79	0,88	0,74
170						0,98	0,92	0,99	0,84	0,99	0,81	0,91	0,75
174						1,00	0,93	1,00	0,85	1,00	0,82	0,92	0,76
176						1,00	0,94		0,85		0,82	0,92	0,76
180							0,95		0,86		0,83	0,93	0,77
190							0,97		0,88		0,84	0,96	0,78
200							1,00		0,90		0,86	0,98	0,80
201							1,00		0,90		0,86	0,98	0,80
209									0,92		0,88	1,00	0,81
210									0,92		0,88		0,81
220									0,94		0,90		0,83
230									0,96		0,92		0,84
240									0,98		0,93		0,86
250									1,00		0,95		0,87
260											0,97		0,89
270											0,99		0,90
276											1,00		0,91
280													0,92
290													0,93
300													0,95
310													0,96
320													0,98
330													0,99
336													1,00

Value without reduction = 1



Influence of spacing (concrete splitting) $\psi_{s,sp}$

s [mm]	TFE														
	Ø6		Ø8		Ø10			Ø12		Ø14		Ø18			
	h_{ef1}	h_{ef3}	h_{ef1}	h_{ef3}	h_{ef1}	h_{ef2}	h_{ef3}	h_{ef1}	h_{ef3}	h_{ef1}	h_{ef3}	h_{ef1}	h_{ef3}		
35	0,69	0,60	0,63	0,59	Invalid value										
40	0,72	0,62	0,65	0,60	Invalid value										
50	0,78	0,65	0,69	0,63	0,68	0,63	0,62	Invalid value							
60	0,83	0,68	0,73	0,65	0,71	0,66	0,64	Invalid value							
70	0,89	0,71	0,77	0,68	0,75	0,68	0,67	Invalid value							
75	0,92	0,72	0,79	0,69	0,77	0,70	0,68	0,70	0,67	Invalid value					
78	0,93	0,73	0,80	0,70	0,78	0,71	0,69	0,71	0,68	Invalid value					
80	0,94	0,74	0,81	0,70	0,79	0,71	0,69	0,71	0,68	0,71	0,67	Invalid value			
90	1,00	0,76	0,85	0,73	0,82	0,74	0,71	0,74	0,70	0,74	0,70	0,70	0,63		
100		0,79	0,88	0,75	0,86	0,76	0,74	0,76	0,73	0,76	0,72	0,72	0,64		
110		0,82	0,92	0,78	0,89	0,79	0,76	0,79	0,75	0,79	0,74	0,74	0,66		
113		0,83	0,93	0,78	0,90	0,80	0,77	0,80	0,76	0,80	0,75	0,75	0,66		
120		0,85	0,96	0,80	0,93	0,82	0,79	0,82	0,77	0,82	0,76	0,76	0,67		
125		0,87	0,98	0,81	0,95	0,83	0,80	0,83	0,78	0,83	0,77	0,77	0,68		
130		0,88	1,00	0,83	0,96	0,84	0,81	0,84	0,80	0,84	0,78	0,78	0,69		
140		0,91		0,85	1,00	0,87	0,83	0,87	0,82	0,87	0,80	0,80	0,70		
150		0,94		0,88		0,89	0,86	0,89	0,84	0,89	0,83	0,83	0,71		
152		0,95		0,88		0,90	0,86	0,90	0,85	0,90	0,83	0,83	0,72		
160		0,97		0,90		0,92	0,88	0,92	0,86	0,92	0,85	0,85	0,73		
170		1,00		0,93		0,95	0,90	0,95	0,89	0,95	0,87	0,87	0,74		
174				0,94		0,96	0,91	0,96	0,90	0,96	0,88	0,88	0,75		
176				0,94		0,96	0,92	0,96	0,90	0,96	0,88	0,88	0,75		
180				0,95		0,97	0,93	0,97	0,91	0,97	0,89	0,89	0,76		
190				0,98		1,00	0,95	1,00	0,93	1,00	0,91	0,91	0,77		
200				1,00			0,98		0,95		0,93	0,93	0,79		
201							0,98		0,96		0,94	0,94	0,79		
209							1,00		0,98		0,95	0,95	0,80		
210							1,00		0,98		0,96	0,96	0,80		
220									1,00		0,98	0,98	0,81		
230											1,00	1,00	0,83		
240													0,84		
250													0,86		
260													0,87		
270													0,89		
276													0,89		
280													0,90		
290													0,91		
300													0,93		
310													0,94		
320													0,96		
330													0,97		
336													0,98		
340													0,99		
350													1,00		

TFE

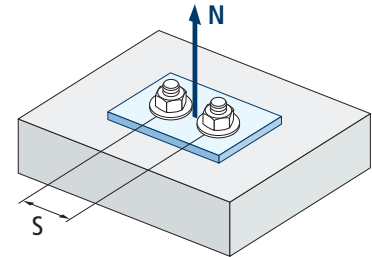

$$\psi_{s,sp} = 0,5 + \frac{s}{2 \cdot s_{cr,sp}} \leq 1$$

Value without reduction = 1



TFE



$$\psi_{c,sp} = 0,35 + \frac{0,5 \cdot c}{C_{cr,sp}} + \frac{0,15 \cdot c^2}{C_{cr,sp}^2} \leq 1$$

Influence of concrete edge distance (splitting) $\psi_{c,sp}$													
c [mm]	TFE												
	Ø6		Ø8		Ø10			Ø12		Ø14		Ø18	
	h_{ef1}	h_{ef3}	h_{ef1}	h_{ef3}	h_{ef1}	h_{ef2}	h_{ef3}	h_{ef1}	h_{ef3}	h_{ef1}	h_{ef3}	h_{ef1}	h_{ef3}
35	0,83	0,58	0,66	0,54	Invalid value								
39	0,90	0,61	0,70	0,57	Invalid value								
40	0,91	0,62	0,71	0,57	0,68	0,59	0,56	Invalid value					
45	1,00	0,66	0,77	0,61	0,73	0,62	0,59	0,62	0,58	Invalid value			
50	0,70		0,82	0,64	0,78	0,65	0,62	0,65	0,61	0,65	0,60	Invalid value	
55	0,74		0,88	0,67	0,84	0,69	0,65	0,69	0,64	0,69	0,62	0,62	0,52
57	0,75		0,90	0,68	0,86	0,70	0,67	0,70	0,65	0,70	0,63	0,63	0,53
60	0,78		0,94	0,70	0,89	0,73	0,68	0,73	0,67	0,73	0,65	0,65	0,54
63	0,80		0,98	0,72	0,92	0,75	0,70	0,75	0,69	0,75	0,67	0,67	0,55
65	0,82		1,00	0,74	0,94	0,76	0,72	0,76	0,70	0,76	0,68	0,68	0,56
70	0,86		0,77		1,00	0,80	0,75	0,80	0,73	0,80	0,71	0,71	0,57
76	0,92		0,82		0,85		0,79	0,85	0,77	0,85	0,75	0,75	0,60
80	0,95		0,85		0,88		0,82	0,88	0,79	0,88	0,77	0,77	0,61
85	1,00		0,88		0,92		0,85	0,92	0,83	0,92	0,80	0,80	0,63
87	0,90		0,90		0,93		0,87	0,93	0,84	0,93	0,81	0,81	0,64
88	0,91		0,91		0,94		0,87	0,94	0,85	0,94	0,82	0,82	0,64
90	0,92		0,92		0,96		0,89	0,96	0,86	0,96	0,83	0,83	0,65
95	0,96		0,96		1,00		0,93	1,00	0,89	1,00	0,87	0,87	0,67
100	0,96		0,96		0,96		0,96		0,96		0,90	0,90	0,68
101	0,97		0,97		0,97		0,97		0,97		0,90	0,90	0,69
104	0,99		0,99		0,99		0,99		0,99		0,92	0,92	0,70
105	1,00		1,00		1,00		1,00		1,00		0,93	0,93	0,70
110	1,00		1,00		1,00		1,00		1,00		0,97	0,97	0,72
115	1,00		1,00		1,00		1,00		1,00		1,00	1,00	0,74
120	1,00		1,00		1,00		1,00		1,00		1,00		0,76
125	1,00		1,00		1,00		1,00		1,00		1,00		0,78
130	1,00		1,00		1,00		1,00		1,00		1,00		0,80
138	1,00		1,00		1,00		1,00		1,00		1,00		0,84
140	1,00		1,00		1,00		1,00		1,00		1,00		0,85
150	1,00		1,00		1,00		1,00		1,00		1,00		0,89
160	1,00		1,00		1,00		1,00		1,00		1,00		0,93
168	1,00		1,00		1,00		1,00		1,00		1,00		0,97
170	1,00		1,00		1,00		1,00		1,00		1,00		0,98
175	1,00		1,00		1,00		1,00		1,00		1,00		1,00



Influence of concrete edge distance (concrete cone) $\psi_{c,N}$													
c [mm]	TFE												
	Ø6		Ø8		Ø10			Ø12		Ø14		Ø18	
	h_{ef1}	h_{ef3}	h_{ef1}	h_{ef3}	h_{ef1}	h_{ef2}	h_{ef3}	h_{ef1}	h_{ef3}	h_{ef1}	h_{ef3}	h_{ef1}	h_{ef3}
35	0,92	0,67	0,72	0,61	Invalid value								
39	1,00	0,71	0,77	0,65									
40		0,72	0,78	0,66	0,73	0,61	0,57	Invalid value					
45		0,77	0,85	0,70	0,79	0,65	0,60						
50		0,83	0,91	0,75	0,85	0,68	0,64	0,69	0,57	0,69	0,55	Invalid value	
55		0,89	0,98	0,79	0,91	0,72	0,67	0,73	0,60	0,73	0,57		
57		0,91	1,00	0,81	0,93	0,74	0,68	0,74	0,61	0,74	0,58	0,67	0,54
60		0,94		0,84	0,97	0,76	0,70	0,77	0,62	0,77	0,60	0,69	0,55
63		0,98		0,87	1,00	0,79	0,72	0,79	0,64	0,79	0,61	0,71	0,56
65		1,00		0,89		0,80	0,74	0,81	0,65	0,81	0,62	0,72	0,57
70				0,94		0,84	0,77	0,85	0,68	0,85	0,64	0,75	0,58
76				1,00		0,90	0,81	0,90	0,71	0,90	0,67	0,79	0,61
80						0,93	0,84	0,94	0,73	0,94	0,69	0,82	0,62
85						0,98	0,88	0,98	0,76	0,98	0,71	0,86	0,64
87						0,99	0,90	1,00	0,77	1,00	0,72	0,87	0,65
88						1,00	0,90		0,78		0,73	0,88	0,65
90							0,92		0,79		0,74	0,89	0,66
95							0,96		0,82		0,77	0,93	0,68
100							1,00		0,84		0,79	0,97	0,70
101							1,00		0,85		0,80	0,98	0,70
104									0,87		0,81	1,00	0,72
105									0,87		0,82		0,72
110									0,90		0,84		0,74
115									0,94		0,87		0,76
120									0,97		0,90		0,78
125									1,00		0,93		0,81
130											0,95		0,83
138											1,00		0,86
140													0,87
150													0,92
160													0,96
168													1,00

TFE

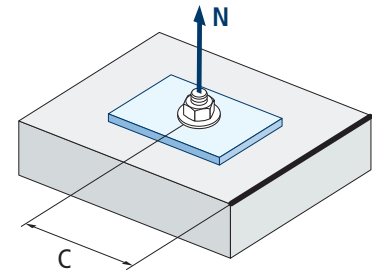

$$\psi_{c,N} = 0,35 + \frac{0,5 \cdot c}{C_{cr,N}} + \frac{0,15 \cdot c^2}{C_{cr,N}^2} \leq 1$$

Value without reduction = 1



TFE

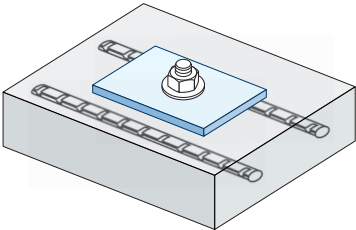

$$\Psi_{re,N} = 0,5 + \frac{h_{ef}}{200} \leq 1$$

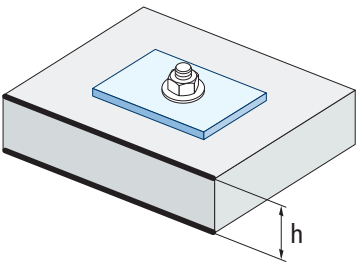

Influence of reinforcements $\Psi_{re,N}$													
TFE													
$\Psi_{re,N}$	Ø6		Ø8		Ø10			Ø12		Ø14		Ø18	
	h_{ef1}	h_{ef3}	h_{ef1}	h_{ef3}	h_{ef1}	h_{ef2}	h_{ef3}	h_{ef1}	h_{ef3}	h_{ef1}	h_{ef3}	h_{ef1}	h_{ef3}
	0,630	0,715	0,688	0,753	0,708	0,793	0,835	0,790	0,918	0,790	0,960	0,848	1,000

*This factor only applies for a high density of reinforcements. If in the area of the anchor there are reinforcements with a distancing of ≥ 150 mm (any diameter) or with a diameter ≤ 10 mm and a distancing of ≥ 100 mm, a $\Psi_{re,N} = 1$ factor may be applied.

Influence of base material thickness $\Psi_{h,sp}$													
TFE													
$\Psi_{h,sp}$	h/h_{ef}	2,00	2,20	2,40	2,60	2,80	3,00	3,20	3,40	3,60	3,60	3,60	$\geq 3,68$
	fh	1,00	1,07	1,13	1,19	1,25	1,31	1,37	1,42	1,48	1,48	1,48	1,50

$$\Psi_{h,sp} = \left(\frac{h}{2 \cdot h_{ef}} \right)^{2/3} \leq 1,5$$

SHEAR LOADS

- Steel design resistance without lever arm: $V_{Rd,s}$
- Pry-out design resistance: $V_{Rd,cp} = k \cdot N_{Rd,c}^o$
- Concrete edge design resistance: $V_{Rd,c} = V_{Rd,c}^o \cdot \Psi_b \cdot \Psi_{se,V} \cdot \Psi_{c,V} \cdot \Psi_{re,V} \cdot \Psi_{\alpha,V} \cdot \Psi_{h,V}$

Steel design resistance							
$V_{Rd,s}$							
Size	Ø6	Ø8	Ø10	Ø12	Ø14	Ø18	
$V_{Rd,s}$	8,35	13,05	18,27	24,83	35,15	53,85	

Pry-out design resistance*							
$V_{Rd,cp} = k \cdot N_{Rd,c}^o$							
Size	Ø6	Ø8	Ø10	Ø12	Ø14	Ø18	
K	h_{ef3}	1,15	1,27	2,00	2	2	2
	h_{ef2}	-	-	1,32	-	-	-
	h_{ef1}	2,05	1,80	1,95	2,33	2,55	2,66

* $N_{Rd,c}^o$ Concrete cone design resistance for tension loads

Concrete edge resistance								
$V_{Rd,c} = V_{Rd,c}^o \cdot \Psi_b \cdot \Psi_{se,V} \cdot \Psi_{c,V} \cdot \Psi_{re,V} \cdot \Psi_{\alpha,V} \cdot \Psi_{h,V}$								
Size	Ø6	Ø8	Ø10	Ø12	Ø14	Ø18		
$V_{Rd,c}$	Non-cracked concrete	h_{ef3}	5,2	6,7	10,8	15,6	18,3	25,3
		h_{ef2}	-	-	8,5	-	-	-
		h_{ef1}	1,8	3,4	4,7	8,3	8,4	11,2
$V_{Rd,c}$	Cracked concrete	h_{ef3}	3,7	4,8	7,7	11,1	13,1	18,1
		h_{ef2}	-	-	6,1	-	-	-
		h_{ef1}	1,3	2,4	3,4	5,9	6,0	8,0

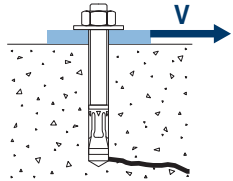
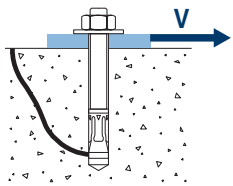
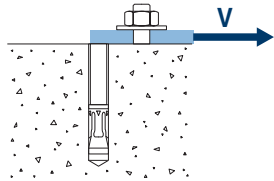



TFE

Coefficients of influence

Influence of concrete strength in concrete edge failure Ψ_b

		Ø6	Ø8	Ø10	Ø12	Ø14	Ø18	
Ψ_b	C 20/25	1,00						
	C 30/37	1,22						
	C 40/50	1,41						
	C 50/60	1,55						

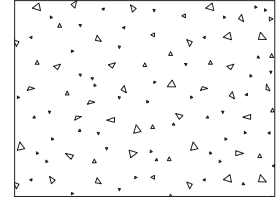

$$\Psi_b = \sqrt{\frac{f_{ck,cube}}{25}} \geq 1$$

Influence of edge distance and spacing $\Psi_{se,V}$

FOR ONE ANCHOR ONLY

c/h_{ef}	0,50	0,75	1,00	1,25	1,50	1,75	2,00	2,25	2,50	2,75	3,00	3,25	3,50	3,75	4,00	4,50	5,00
Isolated	0,35	0,65	1,00	1,40	1,84	2,32	2,83	3,38	3,95	4,56	5,20	5,86	6,55	7,26	8,00	9,55	11,18

FOR TWO ANCHORS

c/h_{ef}	0,50	0,75	1,00	1,25	1,50	1,75	2,00	2,25	2,50	2,75	3,00	3,25	3,50	3,75	4,00	4,50	5,00	
s/c	1,0	0,24	0,43	0,67	0,93	1,22	1,54	1,89	2,25	2,64	3,04	3,46	3,91	4,37	4,84	5,33	6,36	7,45
	1,5	0,27	0,49	0,75	1,05	1,38	1,74	2,12	2,53	2,96	3,42	3,90	4,39	4,91	5,45	6,00	7,16	8,39
	2,0	0,29	0,54	0,83	1,16	1,53	1,93	2,36	2,81	3,29	3,80	4,33	4,88	5,46	6,05	6,67	7,95	9,32
	2,5	0,32	0,60	0,92	1,28	1,68	2,12	2,59	3,09	3,62	4,18	4,76	5,37	6,00	6,66	7,33	8,75	10,25
	≥ 3,0	0,35	0,65	1,00	1,40	1,84	2,32	2,83	3,38	3,95	4,56	5,20	5,86	6,55	7,26	8,00	9,55	11,18

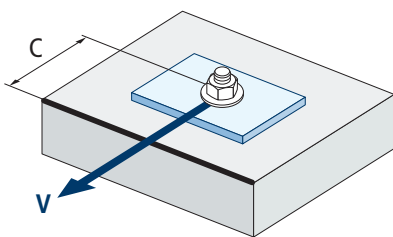

$$\Psi_{se,V} = \left(\frac{c}{h_{ef}}\right)^{1,5}$$

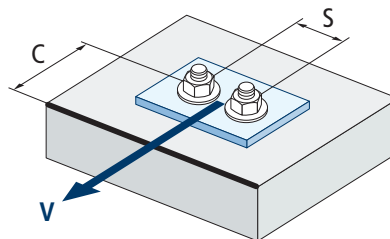

$$\Psi_{se,V} = \left(\frac{c}{h_{ef}}\right)^{1,5} \cdot \left(1 + \frac{s}{3 \cdot c}\right) \cdot 0,5 \leq \left(\frac{c}{h_{ef}}\right)^{1,5}$$



TFE

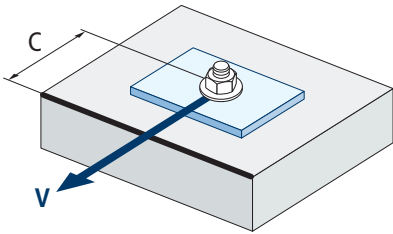

$$\psi_{c,v} = \left(\frac{d}{c} \right)^{0,20}$$

Influence of concrete edge distance $\psi_{c,v}$						
s [mm]	TFE					
	Ø6	Ø8	Ø10	Ø12	Ø14	Ø18
45	0,67					
50	0,65	0,69				
60	0,63	0,67				Invalid value
70	0,61	0,65	0,68			
80	0,60	0,63	0,66			
85	0,59	0,62	0,65	0,68		
90	0,58	0,62	0,64	0,67	0,69	
100	0,57	0,60	0,63	0,65	0,67	
105	0,56	0,60	0,62	0,65	0,67	
110	0,56	0,59	0,62	0,64	0,66	0,70
120	0,55	0,58	0,61	0,63	0,65	0,68
125	0,54	0,58	0,60	0,63	0,65	0,68
128	0,54	0,57	0,60	0,62	0,64	0,68
130	0,54	0,57	0,60	0,62	0,64	0,67
135	0,54	0,57	0,59	0,62	0,64	0,67
140	0,53	0,56	0,59	0,61	0,63	0,66
150	0,53	0,56	0,58	0,60	0,62	0,65
160	0,52	0,55	0,57	0,60	0,61	0,65
170	0,51	0,54	0,57	0,59	0,61	0,64
175	0,51	0,54	0,56	0,59	0,60	0,63
180	0,51	0,54	0,56	0,58	0,60	0,63
190	0,50	0,53	0,55	0,58	0,59	0,62
200	0,50	0,53	0,55	0,57	0,59	0,62
210	0,49	0,52	0,54	0,56	0,58	0,61
220	0,49	0,52	0,54	0,56	0,58	0,61
230	0,48	0,51	0,53	0,55	0,57	0,60
240	0,48	0,51	0,53	0,55	0,57	0,60
250	0,47	0,50	0,53	0,54	0,56	0,59
260	0,47	0,50	0,52	0,54	0,56	0,59
270	0,47	0,49	0,52	0,54	0,55	0,58
280	0,46	0,49	0,51	0,53	0,55	0,58
290	0,46	0,49	0,51	0,53	0,55	0,57
300	0,46	0,48	0,51	0,53	0,54	0,57



Influence of reinforcements $\Psi_{re,v}$			
	Without perimetral reinforcements	Perimetral reinforcements $\geq \text{Ø}12 \text{ mm}$	Perimetral reinforcements with brackets $\leq 100 \text{ mm}$
Non-cracked concrete	1	1	1
Cracked concrete	1	1,2	1,4

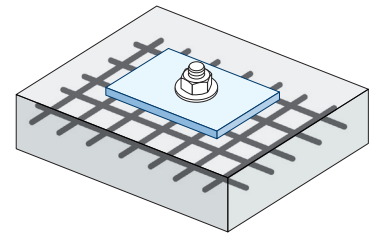

Influence of load application angle $\Psi_{\alpha,v}$										
Angle, $\alpha(^{\circ})$	0°	10°	20°	30°	40°	50°	60°	70°	80°	90°
$\Psi_{\alpha,v}$	1,00	1,01	1,05	1,13	1,24	1,40	1,64	1,97	2,32	2,50

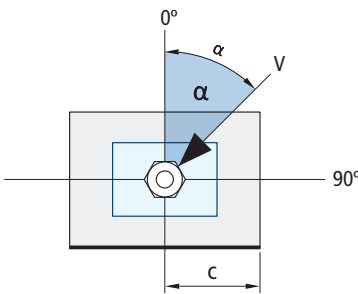

$$\Psi_{\alpha,v} = \sqrt{\frac{1}{(\cos \alpha_v)^2 + \left(\frac{\sin \alpha_v}{2,5}\right)^2}} \geq 1$$

Influence of base material thickness $\Psi_{h,v}$										
TFE										
h/c	0,15	0,30	0,45	0,60	0,75	0,90	1,05	1,20	1,35	$\geq 1,5$
$\Psi_{h,v}$	0,32	0,45	0,55	0,63	0,71	0,77	0,84	0,89	0,95	1,00

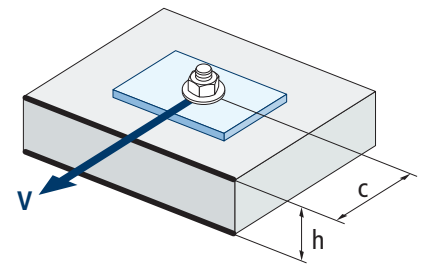

$$\Psi_{h,v} = \left(\frac{h}{1,5 \cdot c}\right)^{0,5} \geq 1,0$$

FIRE RESISTANCE

Characteristic Resistance*													
TENSION							SHEAR						
	Ø6	Ø8	Ø10	Ø12	Ø14	Ø18		Ø6	Ø8	Ø10	Ø12	Ø14	Ø18
RF30	0,26	0,45	1,07	2,01	2,99	4,73	RF30	0,26	0,45	1,07	2,01	2,99	4,74
RF60	0,23	0,41	0,93	1,51	2,24	3,56	RF60	0,23	0,41	0,93	1,51	2,24	3,56
RF90	0,18	0,32	0,71	1,31	1,94	3,07	RF90	0,18	0,32	0,71	1,31	1,94	3,08
RF120	0,13	0,23	0,57	1,01	1,50	2,37	RF120	0,13	0,23	0,57	1,01	1,50	2,37





*The safety factor for design resistance under fire exposure is $\gamma_{M,fi}=1$ (in absence of other national regulations). As a result the Characteristic Resistance is the same as Design Resistance.

Maximum Load Recommended													
TENSION							SHEAR						
	Ø6	Ø8	Ø10	Ø12	Ø14	Ø18		Ø6	Ø8	Ø10	Ø12	Ø14	Ø18
RF30	0,19	0,32	0,76	1,44	2,14	3,38	RF30	0,19	0,32	0,76	1,44	2,14	3,39
RF60	0,16	0,29	0,66	1,08	1,60	2,54	RF60	0,16	0,29	0,66	1,08	1,60	2,54
RF90	0,13	0,23	0,51	0,94	1,39	2,19	RF90	0,13	0,23	0,51	0,94	1,39	2,20
RF120	0,09	0,16	0,41	0,72	1,07	1,69	RF120	0,09	0,16	0,41	0,72	1,07	1,69



TFE

RANGE



THE 						THE 					
Code	Size		Maximum thickness of fixture			Code	Size		Maximum thickness of fixture		
• THE05040	Ø5 x 40	8	5	100	2.400	THE10070	Ø10 x 70	15	15	50	200
• THE05050	Ø5 x 50	8	15	100	1.600	THE10080	Ø10 x 80	15	25	50	300
• THE05060	Ø5 x 60	8	25	100	1.600	THE10090	Ø10 x 90	15	35	25	300
• THE05080	Ø5 x 80	8	45	50	800	THE10100	Ø10 x 100	15	45	25	300
• THE05100	Ø5 x 100	8	65	50	800	THE10120	Ø10 x 120	15	65	25	200
THE06040	Ø6 x 40	10	5	100	1.600	THE10140	Ø10 x 140	15	85	25	100
THE06050	Ø6 x 50	10	15	100	1.200	THE12080	Ø12 x 80	18	5	25	100
THE06060	Ø6 x 60	10	25	100	1.200	THE12090	Ø12 x 90	18	15	25	100
THE06070	Ø6 x 70	10	35	50	600	THE12110	Ø12 x 110	18	35	25	100
THE06080	Ø6 x 80	10	45	50	800	THE12130	Ø12 x 130	18	55	25	150
THE06100	Ø6 x 100	10	65	25	400	THE12150	Ø12 x 150	18	75	25	100
THE06120	Ø6 x 120	10	85	25	400	THE14080	Ø14 x 80	21	5	25	150
THE08055	Ø8 x 55	13	5	50	600	THE14100	Ø14 x 100	21	25	25	150
THE08060	Ø8 x 60	13	10	50	600	THE14120	Ø14 x 120	21	45	25	100
THE08070	Ø8 x 70	13	20	50	200	THE14130	Ø14 x 130	21	55	25	100
THE08080	Ø8 x 80	13	30	25	400	THE14140	Ø14 x 140	21	65	25	100
THE08090	Ø8 x 90	13	40	25	400	THE14160	Ø14 x 160	21	85	25	50
THE08100	Ø8 x 100	13	50	25	400	THE18100	Ø18 x 100	24	10	20	80
THE08110	Ø8 x 110	13	60	25	400	THE18130	Ø18 x 130	24	40	20	40
THE08120	Ø8 x 120	13	70	25	400	THE18160	Ø18 x 160	24	70	15	30
THE08140	Ø8 x 140	13	90	25	300	THE18180	Ø18 x 180	24	90	15	30
THE10060	Ø10 x 60	15	5	50	200	THE18200	Ø18 x 200	24	110	10	20

• Non assessed sizes for structural use. Resistance values and installation data are not applicable to these references. For further information, please contact Technical Department.







TFE

RANGE

TFE 						TFE 					
Code	Size		Maximum thickness of fixture			Code	Size		Maximum thickness of fixture		
• TFE05040	5 x 40	8	5	100	2.400	TFE10070	10 x 70	15	15	50	200
• TFE05050	5 x 50	8	15	100	1.600	TFE10080	10 x 80	15	25	50	300
• TFE05060	5 x 60	8	25	100	1.600	TFE10090	10 x 90	15	35	25	300
• TFE05080	5 x 80	8	45	50	800	TFE10100	10 x 100	15	45	25	300
• TFE05100	5 x 100	8	65	50	800	TFE10120	10 x 120	15	65	25	200
TFE06040	6 x 40	10	5	100	1.600	TFE10140	10 x 140	15	85	25	100
TFE06050	6 x 50	10	15	100	1.200	TFE12080	12 x 80	18	5	25	100
TFE06060	6 x 60	10	25	100	1.200	TFE12090	12 x 90	18	15	25	100
TFE06070	6 x 70	10	35	50	600	TFE12110	12 x 110	18	35	25	100
TFE06080	6 x 80	10	45	50	800	TFE12130	12 x 130	18	55	25	150
TFE06100	6 x 100	10	65	25	400	TFE12150	12 x 150	18	75	25	100
TFE06120	6 x 120	10	85	25	400	TFE14080	14 x 80	21	5	25	150
TFE08055	8 x 55	13	5	50	600	TFE14100	14 x 100	21	25	25	150
TFE08060	8 x 60	13	10	50	600	TFE14120	14 x 120	21	45	25	100
TFE08070	8 x 70	13	20	50	200	TFE14130	14 x 130	21	55	25	100
TFE08080	8 x 80	13	30	25	400	TFE14140	14 x 140	21	65	25	100
TFE08090	8 x 90	13	40	25	400	TFE14160	14 x 160	21	85	25	50
TFE08100	8 x 100	13	50	25	400	TFE18100	18 x 100	24	10	20	80
TFE08110	8 x 110	13	60	25	400	TFE18130	18 x 130	24	40	20	40
TFE08120	8 x 120	13	70	25	400	TFE18160	18 x 160	24	70	15	30
TFE08140	8 x 140	13	90	25	300	TFE18180	18 x 180	24	90	15	30
TFE10060	10 x 60	15	5	50	200	TFE18200	18 x 200	24	110	10	20

• Non assessed sizes for structural use. Resistance values and installation data are not applicable to these references. For further information, please contact Technical Department.

TFN 					
Code	Size		Maximum thickness of fixture		
TFN14080	14 x 80	24	5	25	150



TFE

RANGE

THA



Code	Size		Maximum thickness of fixture		
• THA05040	5 x 40	25	5	100	2.400
• THA05060	5 x 60	25	25	100	1.200
• THA05080	5 x 80	25	45	50	800
• THA05100	5 x 100	25	65	50	800
THA06045	6 x 45	30	10	100	1.200
THA06050	6 x 50	30	15	100	1.200
THA06060	6 x 60	30	25	100	1.200
THA06080	6 x 80	30	45	100	600
THA06120	6 x 120	30	85	100	400
THA06140	6 x 140	30	105	100	600
THA08060	8 x 60	45	10	50	200
THA08080	8 x 80	45	30	25	400
THA08100	8 x 100	45	50	25	400
THA08120	8 x 120	45	70	25	400
THA10100	10 x 100	50	45	25	300
THA10120	10 x 120	50	65	25	200

THT



Code	Size		Maximum thickness of fixture		
THT06040	6 x 40	30	5	100	1.600
THT06050	6 x 50	30	15	100	1.200
THT06060	6 x 60	30	25	100	400

THP



Code	Size		Maximum thickness of fixture		
• THP05040	5 x 40	30	5	100	2.400
• THP05060	5 x 60	30	25	100	1.200
THP06040	6 x 40	40	5	100	1.200
THP06050	6 x 50	40	15	100	1.200
THP06060	6 x 60	40	25	100	1.200
THP06080	6 x 80	40	45	50	600
THP06100	6 x 100	40	65	50	200
THP08060	8 x 60	45	10	25	400
THP08080	8 x 80	45	30	25	300

• Non assessed sizes for structural use. Resistance values and installation data are not applicable to these references. For further information, please contact Technical Department.

TFS



Code	Size		Maximum thickness of fixture		
TFS06100	06 x 100 - M8	5	55	50	800
TFS06120	06 x 120 - M8	5	75	50	600
TFS08110	08 x 100 - M10	7	47	50	400
TFS08130	08 x 130 - M10	7	67	50	400
TFS10120	10 x 120 - M12	8	52	25	200
TFS10140	10 x 140 - M12	8	72	25	200

TFM



Code	Size			
TFM06035	6 x 35 - M8	13	100	400
TFM06055	6 x 55 - M10	13	100	600

TFF



Código	Medida			
TFF06035	6 x 35 - M8/M10	13	50	200
TFF06055	6 x 55 - M8/M10	13	50	200