

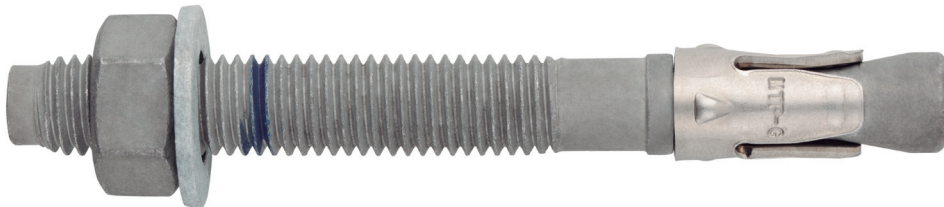

Through-bolt expansion anchor with controlled torque, for use in cracked and non cracked concrete

MTP-G

ETA Assessed option 1. Sherardized shaft. A4 Stainless clip.



PRODUCT INFORMATION

DESCRIPTION

Metallic anchor, with male thread, expansion by controlled torque.

OFFICIAL DOCUMENTATION

- AVCP-1219-CPR-0053.
- ETA 12/0397 option 1.
- Declaration of Performance DoP MTP.

SIZES

M8x50 to M20x200.

DESIGN LOAD RANGE

From 5,6 to 32,8 kN [non-cracked].
From 3,3 to 20,0 kN [cracked].



BASE MATERIAL

Concrete class from C20/25 to C50/60
cracked or non-cracked.



Stone



Concrete



Reinforced Concrete



Cracked Concrete

ASSESSMENTS

- Option 1 [Cracked and non-cracked concrete].
- Fire Resistance R30-120.
- Seismic C1 M8÷M20
- Seismic C2 M12÷M20



CHARACTERISTICS AND BENEFITS

- Easy installation.
- Use in cracked and non-cracked concrete.
- Use for medium-heavy duty loads.
- Pre-installation or through the drill-hole of the fixture.
- Variety of lengths and diameters: flexibility in assembly.
- For static and quasi-static loads.
- Available at INDEXcal.



MATERIALS

Shaft: Carbon steel, sherardized $\geq 40 \mu\text{m}$.

Washer: DIN 125 or DIN 9021, sherardized $\geq 40 \mu\text{m}$.

Nut: DIN 934, sherardized $\geq 40 \mu\text{m}$.

Clip: A4 Stainless steel



APPLICATIONS

- Anchor plates.
- Metallic structures.
- Bridges.
- Urban fitments.
- Protective fences.
- Catenaries.
- Elevators.
- Pipe supports.





MECHANICAL PROPERTIES

			M8	M10	M12	M16	M20
Cone area section							
A_s	(mm ²)	Cone area section	22,9	41,8	55,4	103,9	176,7
$f_{u,s}$	(N/mm ²)	Characteristic tension resistance	790	750	730	700	660
$f_{y,s}$	(N/mm ²)	Yield strength	632	600	585	560	530
Threaded area section							
A_s	(mm ²)	Cone area section	36,6	58,0	84,3	157,0	245,0
$f_{u,s}$	(N/mm ²)	Characteristic tension resistance	600	600	600	600	600
$f_{y,s}$	(N/mm ²)	Yield Strength	480	480	480	480	480

INSTALLATION DATA

SIZE			M8	M10	M12	M16	M20
Code			APG08XXX	APG10XXX	APG12XXX	APG16XXX	APG20XXX
d_0	Nominal diameter of drill bit	[mm]	8	10	12	16	20
T_{ins}	Installation torque moment	[Nm]	15	40	60	100	200
$d_{f\leq}$	Diameter of clearance hole in the fixture	[mm]	9	12	14	18	22
h_1	Minimum drill hole depth	[mm]	60	75	85	105	125
h_{nom}	Installation depth	[mm]	55	68	80	97	114
h_{ef}	Effective embedment depth	[mm]	48	60	70	85	100
h_{min}	Minimum base material thickness	[mm]	100	120	140	170	200
t_{fix}	Maximum thickness of fixture	[mm]	L - 66	L - 80	L - 96	L - 117	L-138
$s_{cr,N}$	Critical spacing	[mm]	144	180	210	255	300
$c_{cr,N}$	Critical edge distance	[mm]	72	90	105	128	150
$s_{cr,sp}$	Critical distance (splitting)	[mm]	288	300	350	510	600
$c_{cr,sp}$	Critical edge distance (splitting)	[mm]	144	150	175	255	300
s_{min}	Minimum spacing	[mm]	40	40	60	65	95
		[mm]	55	70	75	95	105
c_{min}	Minimum edge distance	[mm]	45	45	55	70	95
		[mm]	55	90	110	115	105
SW	Installation wrench		13	17	19	24	30

*L = Total anchor length

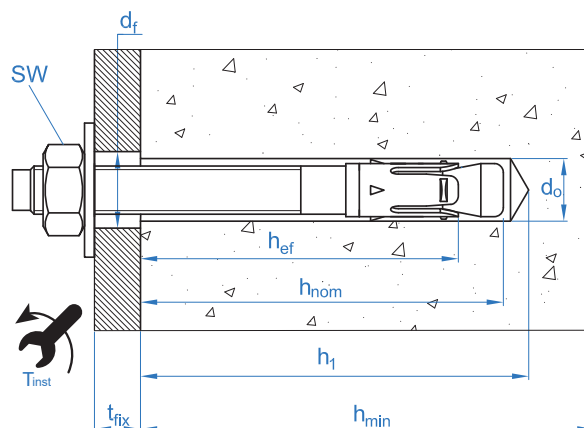



Code	INSTALLATION PRODUCTS
	Hammer drill
BHDSXXXXX	Concrete Drill bits
MOBOMBA	Blow pump
MORCEPKIT	Cleaning Brush
DOMTAXX	Installation hammering tool
	Torque wrench
	Hexagonal socket

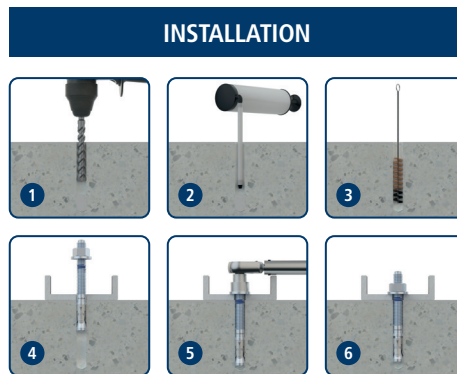

MTP-G

Resistances in C20/25 concrete for an isolated anchor, without effects of edge distance or spacing

Characteristic Resistance N_{Rk} and V_{Rk}													
TENSION							SHEAR						
Size		M8	M10	M12	M16	M20	Size		M8	M10	M12	M16	M20
N_{Rk}	Non-cracked concrete [kN]	10,0	18,0	28,8	36,0	49,2	V_{Rk}	Non-cracked concrete [kN]	11,0	17,4	25,3	47,1	73,1
N_{Rk}	Cracked concrete [kN]	6,0	10,0	16,0	27,0	30,0	V_{Rk}	Cracked concrete [kN]	11,5	17,4	25,3	53,9	68,8

Design Resistance N_{Rd} and V_{Rd}													
TENSION							SHEAR						
Size		M8	M10	M12	M16	M20	Size		M8	M10	M12	M16	M20
N_{Rd}	Non-cracked concrete [kN]	5,6	12,0	19,2	24,0	32,8	V_{Rd}	Non-cracked concrete [kN]	8,8	13,9	20,2	37,7	58,5
N_{Rd}	Cracked concrete [kN]	3,3	6,7	10,7	18,0	20,0	V_{Rd}	Cracked concrete [kN]	7,6	13,9	20,2	35,9	45,9

Maximum Loads Recommended N_{rec} and V_{rec}													
TENSION							SHEAR						
Size		M8	M10	M12	M16	M20	Size		M8	M10	M12	M16	M20
N_{rec}	Non-cracked concrete [kN]	4,0	8,6	13,7	17,1	23,4	V_{rec}	Non-cracked concrete [kN]	6,3	9,9	14,5	26,9	41,8
N_{rec}	Cracked concrete [kN]	2,4	4,8	7,6	12,9	14,3	V_{rec}	Cracked concrete [kN]	5,4	9,9	14,5	25,7	32,8

Simplified calculation method

European Technical Assessment ETA 12/0397

Simplified version of the calculation method according to Eurocode 2 EN 1992-4. Resistance is calculated according to the data shown in assessment 12/0397.

- Influence of concrete strength.
- Influence of edge distance.
- Influence of spacing between anchors.
- Influence of reinforcements.
- Influence of base material thickness.
- Influence of load application angle.
- Valid for a group of two anchors.



INDEXcal

For a more accurate calculation and to take more constructive provisions into account, we recommend using our calculation program INDEXcal. It may be easily downloaded from our website www.indexfix.com



MTP-G

TENSION LOADS

- Steel design resistance: $N_{Rd,s}$
- Pull-out design resistance: $N_{Rd,p} = N_{Rd,p}^o \cdot \Psi_c$
- Concrete cone design resistance: $N_{Rd,c} = N_{Rd,c}^o \cdot \Psi_b \cdot \Psi_{s,N} \cdot \Psi_{c,N} \cdot \Psi_{re,N}$
- Concrete splitting design resistance: $N_{Rd,sp} = N_{Rd,c}^o \cdot \Psi_b \cdot \Psi_{s,sp} \cdot \Psi_{c,sp} \cdot \Psi_{re,N} \cdot \Psi_{h,sp}$

Steel Design resistance						
$N_{Rd,s}$						
Size		M8	M10	M12	M16	M20
N_{Rd}^o	[kN]	12,1	20,9	26,9	48,5	77,7

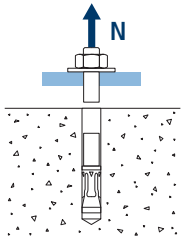

Pull-out design resistance							
$N_{Rd,p} = N_{Rd,p}^o \cdot \Psi_c$							
Size		M8	M10	M12	M16	M20	
$N_{Rd,p}^o$	Non-cracked concrete	[kN]	5,56	12,00	-*	24,00	-*
$N_{Rd,p}^o$	Cracked concrete	[kN]	3,33	6,67	10,67	-*	20,00

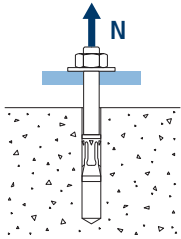

* Pull-out failure is not decisive.

Concrete cone design resistance							
$N_{Rd,c} = N_{Rd,c}^o \cdot \Psi_b \cdot \Psi_{s,N} \cdot \Psi_{c,N} \cdot \Psi_{re,N}$							
Concrete splitting design resistance*							
$N_{Rd,sp} = N_{Rd,c}^o \cdot \Psi_b \cdot \Psi_{s,sp} \cdot \Psi_{c,sp} \cdot \Psi_{re,N} \cdot \Psi_{h,sp}$							
Size		M8	M10	M12	M16	M20	
$N_{Rd,c}^o$	Non-cracked concrete	[kN]	9,1	15,2	19,2	25,7	32,8
$N_{Rd,c}^o$	Cracked concrete	[kN]	6,4	10,7	13,5	18,0	23,0

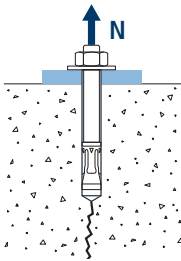
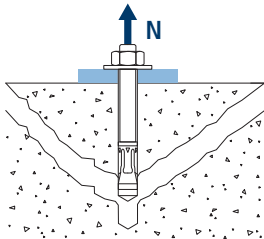

*Concrete splitting design resistance must only be considered for non-cracked concrete.



MTP-G

Coefficients of influence

Influence of concrete strength resistance in pul-out failure Ψ_c

		M8	M10	M12	M16	M20
Ψ_c	C 20/25	1,00				
	C 30/37	1,22	1,17	1,22	1,22	1,17
	C 40/50	1,41	1,31	1,41	1,41	1,31
	C 50/60	1,58	1,43	1,58	1,58	1,43

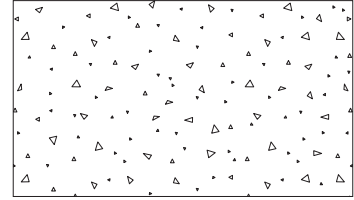
Influence of concrete strength in concret cone and splitting failure Ψ_b

		M8	M10	M12	M16	M20
Ψ_b	C 20/25	1,00				
	C 30/37	1,22				
	C 40/50	1,41				
	C 50/60	1,58				

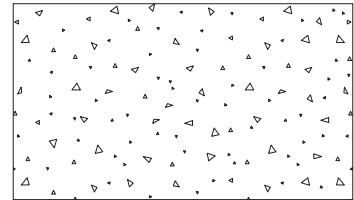

$$\Psi_b = \sqrt{\frac{f_{ck,cube}}{25}} \geq 1$$



MTP-G



$$\psi_{s,N} = 0,5 + \frac{s}{2 \cdot s_{cr,N}} \leq 1$$

Influence of spacing (concrete cone) $\psi_{s,N}$					
s [mm]	MTP-G				
	M8	M10	M12	M16	M20
40	0,64	0,61			
50	0,67	0,64			
55	0,69	0,65			
60	0,71	0,67	0,64		
65	0,73	0,68	0,65	0,63	
70	0,74	0,69	0,67	0,64	
80	0,78	0,72	0,69	0,66	
85	0,80	0,74	0,70	0,67	
90	0,81	0,75	0,71	0,68	
95	0,83	0,76	0,73	0,69	
100	0,85	0,78	0,74	0,70	
105	0,86	0,79	0,75	0,71	
110	0,88	0,81	0,76	0,72	
120	0,92	0,83	0,79	0,74	
125	0,93	0,85	0,80	0,75	0,71
126	0,94	0,85	0,80	0,75	0,71
128	0,94	0,86	0,80	0,75	0,71
130	0,95	0,86	0,81	0,75	0,72
135	0,97	0,88	0,82	0,76	0,73
144	1,00	0,90	0,84	0,78	0,74
150		0,92	0,86	0,79	0,75
165		0,96	0,89	0,82	0,78
170		0,97	0,90	0,83	0,78
180		1,00	0,93	0,85	0,80
195			0,96	0,88	0,83
200			0,98	0,89	0,83
210			1,00	0,91	0,85
220				0,93	0,87
225				0,94	0,88
252				0,99	0,92
255				1,00	0,93
260					0,93
300					1,00

Invalid value

Value without reduction = 1



Influence of spacing (concrete splitting) $\psi_{s,sp}$						
s [mm]	MTP-G					
	M8	M10	M12	M16	M20	
40	0,57	0,57	Invalid value			
50	0,59	0,58				
55	0,60	0,59				
60	0,60	0,60	0,59	Invalid value		
65	0,61	0,61	0,59			0,56
70	0,62	0,62	0,60			0,57
80	0,64	0,63	0,61	0,58	Invalid value	
85	0,65	0,64	0,62	0,58		
90	0,66	0,65	0,63	0,59		
95	0,66	0,66	0,64	0,59	0,58	
100	0,67	0,67	0,64	0,60	0,58	
110	0,69	0,68	0,66	0,61	0,59	
125	0,72	0,71	0,68	0,62	0,60	
128	0,72	0,71	0,68	0,63	0,61	
135	0,73	0,73	0,69	0,63	0,61	
140	0,74	0,73	0,70	0,64	0,62	
150	0,76	0,75	0,71	0,65	0,63	
160	0,78	0,77	0,73	0,66	0,63	
165	0,79	0,78	0,74	0,66	0,64	
168	0,79	0,78	0,74	0,66	0,64	
180	0,81	0,80	0,76	0,68	0,65	
192	0,83	0,82	0,77	0,69	0,66	
200	0,85	0,83	0,79	0,70	0,67	
210	0,86	0,85	0,80	0,71	0,68	
220	0,88	0,87	0,81	0,72	0,68	
260	0,95	0,93	0,87	0,75	0,72	
280	0,99	0,97	0,90	0,77	0,73	
288	1,00	0,98	0,91	0,78	0,74	
300	Value without reduction = 1		0,93	0,79	0,75	
336			0,98	0,83	0,78	
350			1,00	0,84	0,79	
360	Value without reduction = 1		Value without reduction = 1		0,85	0,80
412					0,90	0,84
425					0,92	0,85
500	Value without reduction = 1		Value without reduction = 1		0,99	0,92
510					1,00	0,93
560					Value without reduction = 1	
600	1,00					

MTP-G

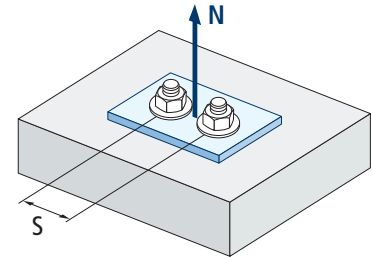

$$\psi_{s,sp} = 0,5 + \frac{s}{2 \cdot s_{cr,sp}} \leq 1$$



MTP-G

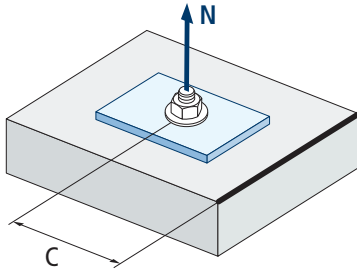

$$\psi_{c,sp} = 0,35 + \frac{0,5 \cdot c}{C_{cr,sp}} + \frac{0,15 \cdot c^2}{C_{cr,sp}^2} \leq 1$$

Influence of concrete edge distance (splitting) $\psi_{c,sp}$					
c [mm]	MTP-G				
	M8	M10	M12	M16	M20
45	0,52	0,51			
50	0,54	0,53			
55	0,56	0,55	0,52		
60	0,58	0,57	0,54		
65	0,61	0,59	0,56		
70	0,63	0,62	0,57	0,50	
75	0,65	0,64	0,59	0,51	
80	0,67	0,66	0,61	0,52	
83	0,69	0,67	0,62	0,53	
84	0,69	0,68	0,62	0,53	
85	0,70	0,68	0,63	0,53	
90	0,72	0,70	0,65	0,55	
95	0,75	0,73	0,67	0,56	0,52
100	0,77	0,75	0,68	0,57	0,53
105	0,79	0,77	0,70	0,58	0,54
110	0,82	0,80	0,72	0,59	0,55
125	0,90	0,87	0,78	0,63	0,58
128	0,91	0,89	0,80	0,64	0,59
130	0,92	0,90	0,80	0,64	0,59
135	0,95	0,92	0,82	0,66	0,61
140	0,98	0,95	0,85	0,67	0,62
144	1,00	0,97	0,86	0,68	0,62
150		1,00	0,89	0,70	0,64
168			0,97	0,74	0,68
175			1,00	0,76	0,69
180				0,78	0,70
206				0,85	0,76
213				0,87	0,78
250				0,98	0,87
255				1,00	0,88
280					0,95
300					1,00

Value without reduction = 1

Invalid value



Influence of concrete edge distance (concrete cone) $\psi_{c,N}$							
c [mm]	MTP-G						
	M8	M10	M12	M16	M20		
40	0,67	0,60	Invalid value				
50	0,77	0,67					
53	0,80	0,70					
60	0,87	0,75					
63	0,90	0,77					
65	0,92	0,79				0,72	
70	0,98	0,83				0,75	
72	1,00	0,85				0,76	
75		0,87				0,78	
80		0,91				0,82	
83		0,94				0,84	
85		0,96				0,85	
90		1,00				0,89	
95						0,93	0,80
100						0,96	0,83
105			1,00	0,86			
110				0,89			
113				0,91			
125				0,98	0,87		
126				0,99	0,88		
128				1,00	0,89		
135					0,92		
150					1,00		

Value without reduction = 1

MTP-G

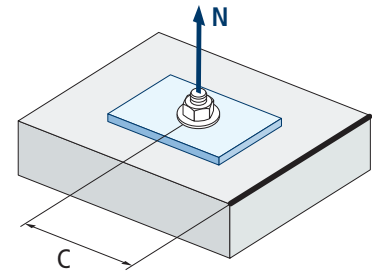

$$\psi_{c,N} = 0,35 + \frac{0,5 \cdot c}{C_{cr,N}} + \frac{0,15 \cdot c^2}{C_{cr,N}^2} \leq 1$$

Influence of reinforcements $\psi_{re,N}$					
$\psi_{re,N}$	MTP-G				
	M8	M10	M12	M16	M20
	0,74	0,80	0,85	0,93	1,00

*This factor only applies for a high density of reinforcements. If in the area of the anchor there are reinforcements with a distancing of ≥ 150 mm (any diameter) or with a diameter ≤ 10 mm and a distancing of ≥ 100 mm, a $f_{re,N} = 1$ factor may be applied.

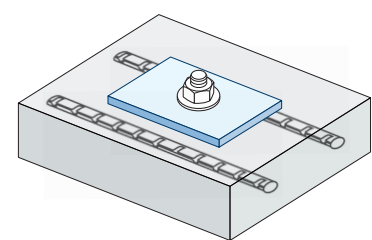

$$\psi_{re,N} = 0,5 + \frac{h_{ef}}{200} \leq 1$$

Influence of base material thickness $\psi_{h,sp}$											
$\psi_{h,sp}$	MTP-G										
	h/h _{ef}	2,00	2,20	2,40	2,60	2,80	3,00	3,20	3,40	3,60	$\geq 3,68$
	$\psi_{h,sp}$	1,00	1,07	1,13	1,19	1,25	1,31	1,37	1,42	1,48	1,50

$$\psi_{h,sp} = \left(\frac{h}{2 \cdot h_{ef}} \right)^{2/3} \leq 1,5$$

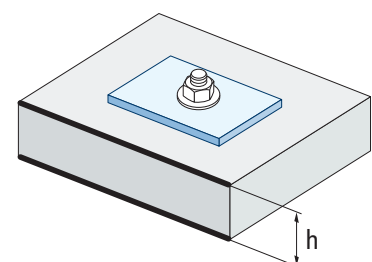



MTP-G

SHEAR LOADS

- Steel design resistance without lever arm: $V_{Rd,s}$
- Pry-out design resistance: $V_{Rd,cp} = k \cdot N_{Rd,c}^o$
- Concrete edge design resistance: $V_{Rd,c} = V_{Rd,c}^o \cdot \psi_b \cdot \psi_{se,V} \cdot \psi_{c,V} \cdot \psi_{re,V} \cdot \psi_{\alpha,V} \cdot \psi_{h,V}$

Steel design resistance						
$V_{Rd,s}$						
Size		M8	M10	M12	M16	M20
$V_{Rd,s}$	[kN]	8,8	13,9	20,2	37,7	58,5

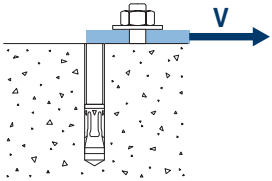

Pry-out design resistance*						
$V_{Rd,cp} = k \cdot N_{Rd,c}^o$						
Size		M8	M10	M12	M16	M20
k		1	2	2	2	2

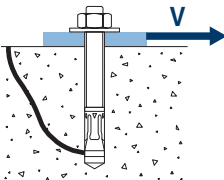

* $N_{Rd,c}^o$ Concrete cone design resistance for tension loads

Concrete edge resistance							
$V_{Rd,c} = V_{Rd,c}^o \cdot \psi_b \cdot \psi_{se,V} \cdot \psi_{c,V} \cdot \psi_{re,V} \cdot \psi_{\alpha,V} \cdot \psi_{h,V}$							
Size		M8	M10	M12	M16	M20	
$V_{Rd,c}^o$	Non-cracked concrete	[kN]	6,2	8,9	11,5	15,9	20,8
	Cracked concrete	[kN]	4,4	6,3	8,2	11,3	14,7

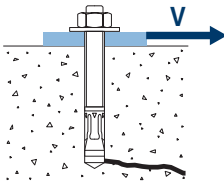



MTP-G

Coefficients of influence

Influence of concrete strength in concrete edge failure Ψ_b

		M8	M10	M12	M16	M20
Ψ_b	C 20/25	1,00				
	C 30/37	1,22				
	C 40/50	1,41				
	C 50/60	1,55				

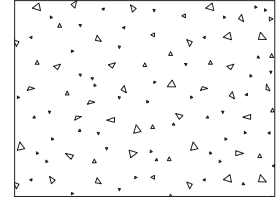

$$\Psi_b = \sqrt{\frac{f_{ck,cube}}{25}} \geq 1$$

Influence of edge distance and spacing $\Psi_{se,V}$

FOR ONE ANCHOR ONLY

c/h_{ef}	0,50	0,75	1,00	1,25	1,50	1,75	2,00	2,25	2,50	2,75	3,00	3,25	3,50	3,75	4,00	4,50	5,00
Isolated	0,35	0,65	1,00	1,40	1,84	2,32	2,83	3,38	3,95	4,56	5,20	5,86	6,55	7,26	8,00	9,55	11,18

FOR TWO ANCHORS

c/h_{ef}	0,50	0,75	1,00	1,25	1,50	1,75	2,00	2,25	2,50	2,75	3,00	3,25	3,50	3,75	4,00	4,50	5,00	
s/c	1,0	0,24	0,43	0,67	0,93	1,22	1,54	1,89	2,25	2,64	3,04	3,46	3,91	4,37	4,84	5,33	6,36	7,45
	1,5	0,27	0,49	0,75	1,05	1,38	1,74	2,12	2,53	2,96	3,42	3,90	4,39	4,91	5,45	6,00	7,16	8,39
	2,0	0,29	0,54	0,83	1,16	1,53	1,93	2,36	2,81	3,29	3,80	4,33	4,88	5,46	6,05	6,67	7,95	9,32
	2,5	0,32	0,60	0,92	1,28	1,68	2,12	2,59	3,09	3,62	4,18	4,76	5,37	6,00	6,66	7,33	8,75	10,25
	≥3,0	0,35	0,65	1,00	1,40	1,84	2,32	2,83	3,38	3,95	4,56	5,20	5,86	6,55	7,26	8,00	9,55	11,18

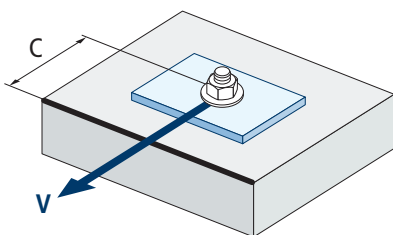

$$\Psi_{se,V} = \left(\frac{c}{h_{ef}}\right)^{1,5}$$

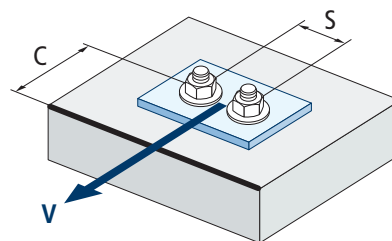

$$\Psi_{se,V} = \left(\frac{c}{h_{ef}}\right)^{1,5} \cdot \left(1 + \frac{s}{3 \cdot c}\right) \cdot 0,5 \leq \left(\frac{c}{h_{ef}}\right)^{1,5}$$



MTP-G

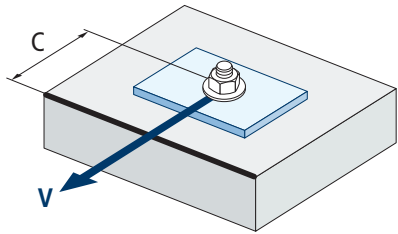

$$\psi_{c,v} = \left(\frac{d}{c} \right)^{0,20}$$

Influence of concrete edge distance $\psi_{c,v}$					
c [mm]	MTP-G				
	M8	M10	M12	M16	M20
40					
45					
50	0,69				
55	0,68				
60	0,67	0,70			
65	0,66	0,69	0,71		
70	0,65	0,68	0,70		
80	0,63	0,66	0,68		
85	0,62	0,65	0,68	0,72	
90	0,62	0,64	0,67	0,71	
100	0,60	0,63	0,65	0,69	0,72
105	0,60	0,62	0,65	0,69	0,72
110	0,59	0,62	0,64	0,68	0,71
120	0,58	0,61	0,63	0,67	0,70
125	0,58	0,60	0,63	0,66	0,69
130	0,57	0,60	0,62	0,66	0,69
135	0,57	0,59	0,62	0,65	0,68
140	0,56	0,59	0,61	0,65	0,68
150	0,56	0,58	0,60	0,64	0,67
160	0,55	0,57	0,60	0,63	0,66
170	0,54	0,57	0,59	0,62	0,65
175	0,54	0,56	0,59	0,62	0,65
180	0,54	0,56	0,58	0,62	0,64
190	0,53	0,55	0,58	0,61	0,64
200	0,53	0,55	0,57	0,60	0,63
210	0,52	0,54	0,56	0,60	0,62
220	0,52	0,54	0,56	0,59	0,62
230	0,51	0,53	0,55	0,59	0,61
240	0,51	0,53	0,55	0,58	0,61
250	0,50	0,53	0,54	0,58	0,60
260	0,50	0,52	0,54	0,57	0,60
270	0,49	0,52	0,54	0,57	0,59
280	0,49	0,51	0,53	0,56	0,59
290	0,49	0,51	0,53	0,56	0,59
300	0,48	0,51	0,53	0,56	0,58



Influence of reinforcements $\Psi_{re,v}$			
	Without perimetral reinforcements	Perimetral reinforcements $\geq \text{Ø}12$ mm	Perimetral reinforcements with brackets ≤ 100 mm
Non-cracked concrete	1	1	1
Cracked concrete	1	1,2	1,4

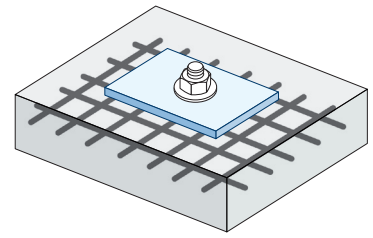

Influence of load application angle $\Psi_{\alpha,v}$											
Angle, $\alpha(^{\circ})$	0°	10°	20°	30°	40°	50°	60°	70°	80°	90°	
$\Psi_{\alpha,v}$	1,00	1,01	1,05	1,13	1,24	1,40	1,64	1,97	2,32	2,50	

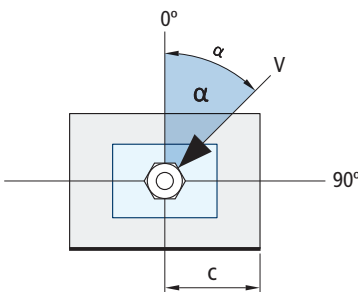

$$\Psi_{\alpha,v} = \sqrt{\frac{1}{(\cos \alpha_v)^2 + \left(\frac{\sin \alpha_v}{2,5}\right)^2}} \geq 1$$

Influence of base material thickness $\Psi_{h,v}$											
MTP-G											
h/c	0,15	0,30	0,45	0,60	0,75	0,90	1,05	1,20	1,35	$\geq 1,5$	
$\Psi_{h,v}$	0,32	0,45	0,55	0,63	0,71	0,77	0,84	0,89	0,95	1,00	

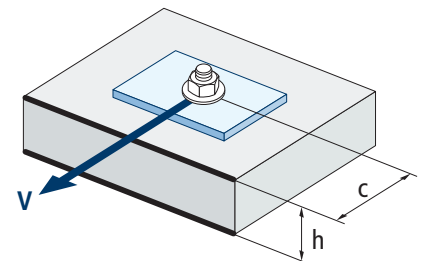

$$\Psi_{h,v} = \left(\frac{h}{1,5 \cdot c}\right)^{0,5} \geq 1,0$$



MTP-G

FIRE RESISTANCE

Characteristic Resistance*										
	TENSION					SHEAR				
	M8	M10	M12	M16	M20	M8	M10	M12	M16	M20
RF30	0,4	0,9	1,7	3,1	4,9	0,4	0,9	1,7	3,1	4,9
RF60	0,3	0,8	1,3	2,4	3,7	0,3	0,8	1,3	2,4	3,7
RF90	0,3	0,6	1,1	2,0	3,2	0,3	0,6	1,1	2,0	3,2
RF120	0,2	0,5	0,8	1,6	2,5	0,2	0,5	0,8	1,6	2,5

*The safety factor for design resistance under fire exposure is $\gamma_{M,fi}=1$ (in absence of other national regulations). As a result the Characteristic Resistance is the same as Design Resistance.

Maximum Load Recommended										
	TENSION					SHEAR				
	M8	M10	M12	M16	M20	M8	M10	M12	M16	M20
RF30	0,3	0,6	1,2	2,2	3,5	0,3	0,6	1,2	2,2	3,5
RF60	0,2	0,6	0,9	1,7	2,6	0,2	0,6	0,9	1,7	2,6
RF90	0,2	0,4	0,8	1,4	2,3	0,2	0,4	0,8	1,4	2,3
RF120	0,1	0,4	0,6	1,1	1,8	0,1	0,4	0,6	1,1	1,8

RANGE

Code	Size	Maximum thickness of fixture	Axle letter (length)			Code	Size	Maximum thickness of fixture	Axle letter (length)		
• APG06060	M6 x 60 Ø6	10	B	200	1.200	• APG12080	M12 x 80 Ø12	4	D	50	300
• APG06070	M6 x 70 Ø6	20	C	200	1.200	APG12110	M12 x 110 Ø12	14	F	50	200
• APG06100	M6 x 100 Ø6	50	E	200	800	APG12130	M12 x 130 Ø12	34	H	50	200
• APG08050	M8 x 50 Ø8	2	A	100	800	APG12150	M12 x 150 Ø12	54	I	50	100
• APG08060	M8 x 60 Ø8	12	B	100	800	APG12160	M12 x 160 Ø12	64	J	50	100
APG08075	M8 x 75 Ø8	9	C	100	600	APG12180	M12 x 180 Ø12	84	L	50	150
APG08095	M8 x 95 Ø8	29	E	100	600	APG12200	M12 x 200 Ø12	104	M	50	150
APG08115	M8 x 115 Ø8	49	G	100	400	APG16125	M16 x 125 Ø16	8	G	25	100
• APG10070	M10 x 70 Ø10	5	C	100	400	APG16145	M16 x 145 Ø16	28	I	25	100
APG10090	M10 x 90 Ø10	10	E	100	400	APG16175	M16 x 175 Ø16	58	K	25	50
APG10105	M10 x 105 Ø10	25	F	50	300	APG16220	M16 x 220 Ø16	103	O	25	50
APG10115	M10 x 115 Ø10	35	G	50	200	APG16250	M16 x 250 Ø16	133	Q	25	50
APG10135	M10 x 135 Ø10	55	H	50	200	APG20170	M20 x 170 Ø20	32	K	20	40
APG10165	M10 x 165 Ø10	85	K	50	200	APG20200	M20 x 200 Ø20	62	M	20	40
APG10185	M10 x 185 Ø10	105	L	50	150						

• Non assessed sizes. Resistance values and installation data are not applicable to these references. For further information, please contact Technical Department.