



**Technical and Test Institute  
for Construction Prague**

Prosecká 811/76a  
190 00 Prague  
Czech Republic  
eota@tzus.cz



Member of



www.eota.eu

## European Technical Assessment

## ETA 23/0551 of 13/07/2023

**Technical Assessment Body issuing the ETA:** Technical and Test Institute  
for Construction Prague

**Trade name of the construction product**

MO-PUS

**Product family to which the construction  
product belongs**

Product area code: 33  
Injection anchors for use in masonry

**Manufacturer**

Index Técnicas Expansivas, S.L.  
P.I. La Portalada II C. Segador 13  
26006 Logroño  
Spain  
<https://www.indexfix.com/>

**Manufacturing plant(s)**

Index Plant 1

**This European Technical Assessment  
contains**

14 pages including 11 Annexes which form  
an integral part of this assessment.

**This European Technical Assessment is  
issued in accordance with regulation  
(EU) No 305/2011, on the basis of**

EAD 330076-01-0604 Metal injection  
anchors for use in masonry

Translations of this European Technical Assessment in other languages shall fully correspond to the original issued document and should be identified as such.

Communication of this European Technical Assessment, including transmission by electronic means, shall be in full (excepted the confidential Annex(es) referred to above). However, partial reproduction may be made, with the written consent of the issuing Technical Assessment Body. Any partial reproduction has to be identified as such.

## 1. Technical description of the product

The MO-PUS for masonry is a bonded anchor consisting of a cartridge with injection mortar, a plastic sieve sleeve and an anchor rod with hexagon nut and washer. The steel elements are made of galvanized steel or stainless steel.

The sieve sleeve is pushed into a drilled hole and filled with injection mortar before the anchor rod is placed in the sieve sleeve. The installation of the anchor rod in solid masonry can be also done without a sieve sleeve. The steel element is anchored via the bond between metal part, injection mortar and masonry.

The illustration and the description of the product are given in Annex A.

## 2. Specification of the intended use in accordance with the applicable EAD

The performances given in Section 3 are only valid if the anchor is used in compliance with the specifications and conditions given in Annex B.

The provisions made in this European Technical Assessment are based on an assumed working life of the anchor of 50 years. The indications given on the working life cannot be interpreted as a guarantee given by the producer, but are to be regarded only as a means for choosing the products in relation to the expected economically reasonable working life of the works.

## 3. Performance of the product and references to the methods used for its assessment

### 3.1 Mechanical resistance and stability (BWR 1)

Essential characteristic	Performance
Characteristic resistance for tension and shear loads	See Annex C 1
Reduction factor for job site tests ( $\beta$ – factor)	See Annex C 1
Edge distances and spacing	See Annex B 6
Displacement under shear and tension loads	See Annex C 1
Durability	See Annex A 3

### 3.2 Safety in case of fire (BWR 2)

Essential characteristic	Performance
Reaction to fire	Anchorage satisfy requirements for Class A1

### 3.3 Hygiene, health and environment (BWR 3)

No performance determined.

### 3.4 General aspects relating to fitness for use

Durability and serviceability are only ensured if the specifications of intended use according to Annex B 1 are kept.

## 4. Assessment and verification of constancy of performance (AVCP) system applied with reference to its legal base

According to the Decision 97/177/EC of the European Commission<sup>1</sup>, the system of assessment and verification of constancy of performance (see Annex V to Regulation (EU) No 305/2011) given in the following table applies.

Product	Intended use	Level or class	System
Injection anchors for use in masonry	For fixing and/or supporting to masonry, structural elements (which contributes to the stability of the works) or heavy units	-	1

<sup>1</sup> Official Journal of the European Communities L 073 of 14.03.1997

**5. Technical details necessary for the implementation of the AVCP system, as provided in the applicable EAD**

The factory production control shall be in accordance with the control plan which is a part of the technical documentation of this European Technical Assessment. The control plan is laid down in the context of the factory production control system operated by the manufacturer and deposited at Technical and Test Institute for Construction Prague<sup>2</sup>. The results of the factory production control shall be recorded and evaluated in accordance with the provisions of the control plan.

Issued in Prague on 13.07.2023

By

**Ing. Jiří Studnička, Ph.D.**  
Head of the Technical Assessment Body



---

<sup>2</sup> The control plan is a confidential part of the documentation of the European technical assessment, but not published together with the ETA and only handed over to the approved body involved in the procedure of AVCP.

### Installation in hollow or perforated brick masonry

Installation of anchor rod with sieve sleeve

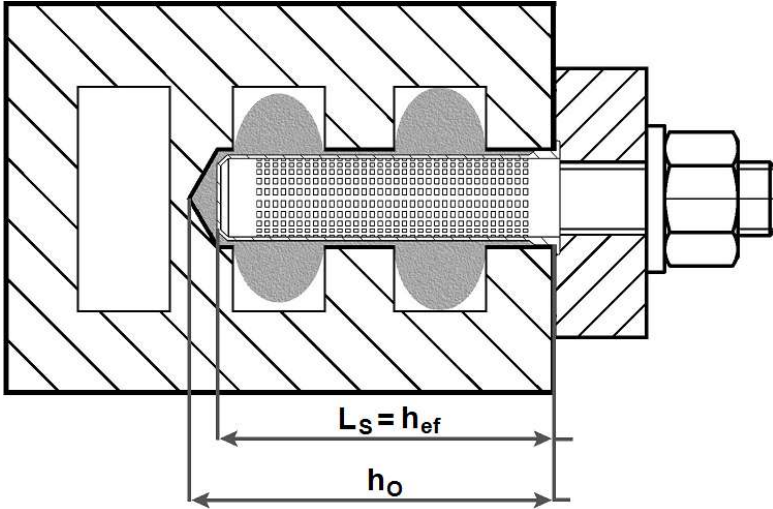

### Installation in solid brick masonry

Installation of anchor rod with or without sieve sleeve

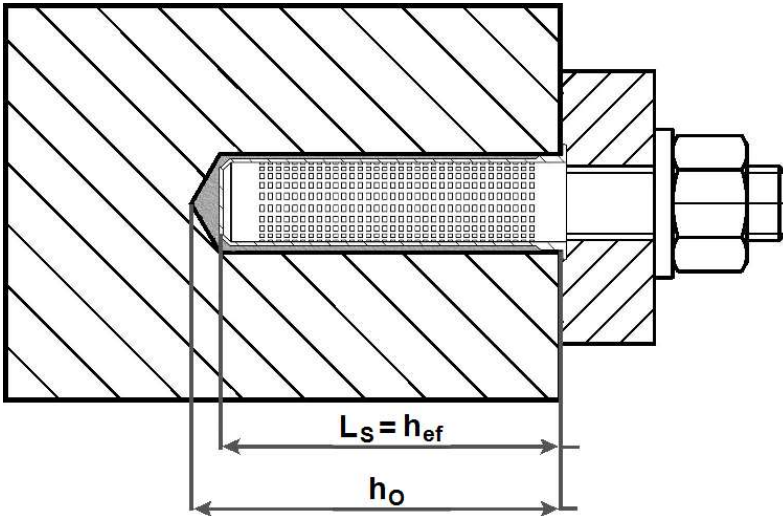

- $L_s$  = length of the sieve sleeve
- $h_{ef}$  = effective setting depth
- $h_0$  = bore hole depth

**MO-PUS  
for masonry**

**Product description**  
Installed condition

**Annex A 1**

**Coaxial cartridge (CC)**

150 ml  
380 ml  
400 ml  
410 ml



**Side by side cartridge (SBS)**

350 ml  
825 ml

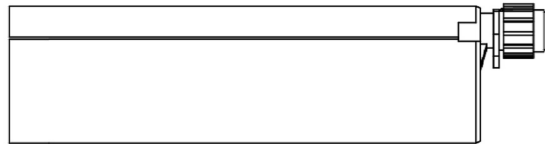

**Two part foil in a single piston component cartridge (FCC)**

150 ml  
170 ml  
300 ml  
550 ml  
850 ml



**Peeler cartridge (PLR)**

280 ml



**Marking of the mortar cartridges**

Identifying mark of the producer, Trade name, Charge code number, Storage life, Curing and processing time

**Mixing nozzle**

KW



RC

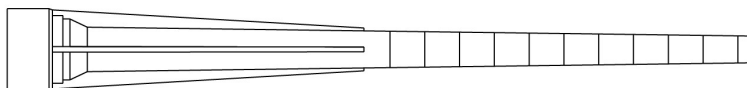

EZ-Flow



RM

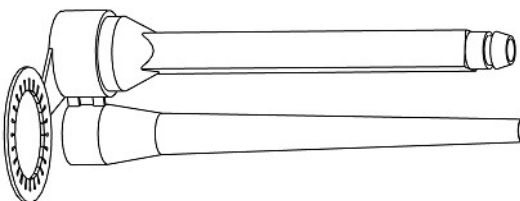

TB

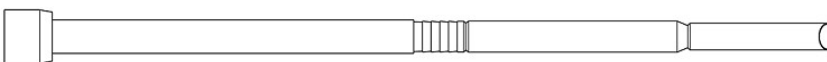

KR for 850

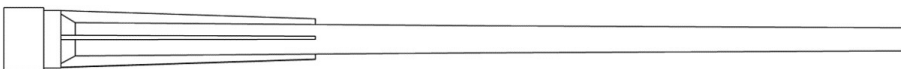

**MO-PUS  
for masonry**

**Product description**  
Injection system

**Annex A 2**

## Threaded rod M8, M10, M12

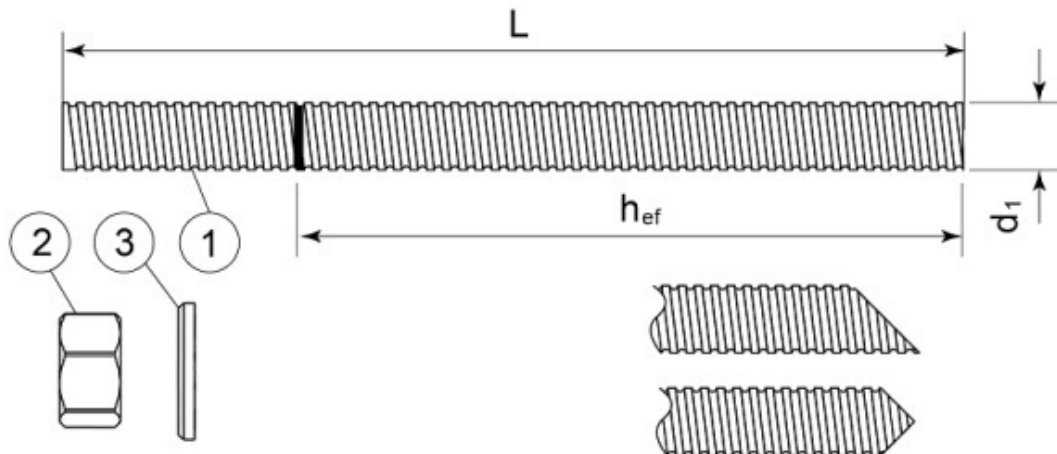

Standard commercial threaded rod with marked embedment depth

Part	Designation	Material
<b>Steel, zinc plated <math>\geq 5 \mu\text{m}</math> acc. to EN ISO 4042 or Steel, hot-dip galvanized <math>\geq 40 \mu\text{m}</math> acc. to EN ISO 1461 and EN ISO 10684 or Steel, zinc diffusion coating <math>\geq 15 \mu\text{m}</math> acc. to EN 13811</b>		
1	Anchor rod	Steel, EN 10087 or EN 10263 Property class 5.8, 8.8, 10.9* EN ISO 898-1
2	Hexagon nut EN ISO 4032	According to threaded rod, EN 20898-2
3	Washer EN ISO 887, EN ISO 7089, EN ISO 7093 or EN ISO 7094	According to threaded rod
<b>Stainless steel</b>		
1	Anchor rod	Material: A2-70, A4-70, A4-80, EN ISO 3506
2	Hexagon nut EN ISO 4032	According to threaded rod
3	Washer EN ISO 887, EN ISO 7089, EN ISO 7093 or EN ISO 7094	According to threaded rod
<b>High corrosion resistant steel</b>		
1	Anchor rod	Material: 1.4529, 1.4565, EN 10088-1
2	Hexagon nut EN ISO 4032	According to threaded rod
3	Washer EN ISO 887, EN ISO 7089, EN ISO 7093 or EN ISO 7094	According to threaded rod

\*Galvanized rod of high strength are sensitive to hydrogen induced brittle failure

**MO-PUS  
for masonry**

**Product description**  
Threaded rod and materials

**Annex A 3**

**Sieve sleeve**

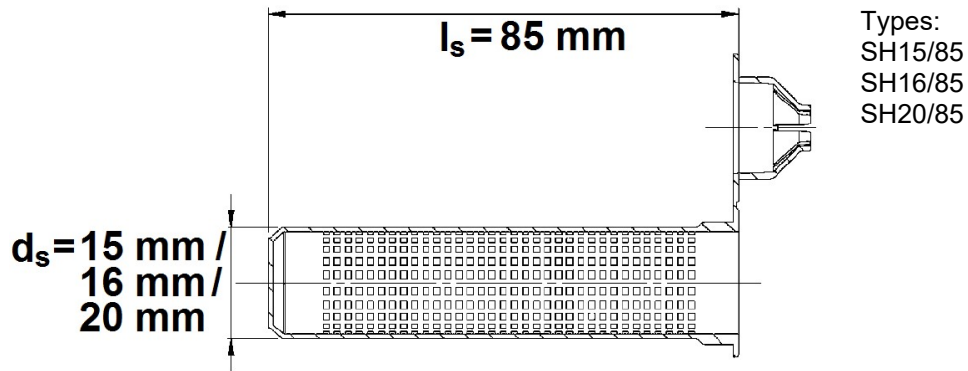

Designation	Material
Sieve sleeve	Polypropylene

**MO-PUS  
for masonry**

**Product description**  
Sleeve

**Annex A 4**

## Specifications of intended use

### Anchorage subject to:

- Static and quasi-static loads

### Base materials

- Solid brick masonry (Masonry group b), according to Annex B2.
- Hollow brick masonry (Masonry group c), according to Annex B2 to B3.
- Mortar strength class of the masonry M2,5 at minimum according to EN 998-2:2010.
- For other bricks in solid masonry and in hollow or perforated masonry, the characteristic resistance of the anchorages may be determined by job site tests according to EOTA Technical Report TR 053 and under consideration of the  $\beta$ -factor to Annex C1, Table C4.

Note: The characteristic resistance for solid bricks are also valid for larger brick sizes and larger compressive strength of the masonry unit.

### Temperature range:

- T: -40°C to +80°C (max. short. term temperature +80°C and max. long term temperature +50°C)

### Use conditions (Environmental conditions)

- (X1) Structures subject to dry internal conditions (zinc coated steel)

### Use conditions in respect of installation and use:

- Category d/d - Installation and use in structures subject to dry, internal conditions
- Category w/d - Installation in dry or wet substrate and use in structures subject to dry, internal conditions

### Design:

- Verifiable calculation notes and drawings are prepared taking account the relevant masonry in the region of the anchorage, the loads to be transmitted and their transmission to the supports of the structure. The position of the anchor is indicated on the design drawings.
- The anchorages are designed in accordance with the EOTA Technical Report TR 054, Design method A,, under the responsibility of an engineer experienced in anchorages and masonry work.

### Installation:

- Dry or wet structures
- Anchor Installation carried out by appropriately qualified personnel and under the supervision of the person responsible for technical matters of the site.

**MO-PUS  
for masonry**

**Intended use  
Specifications**

**Annex B 1**



**Table B1: Types and dimensions of block and bricks**

**Brick N° 1**

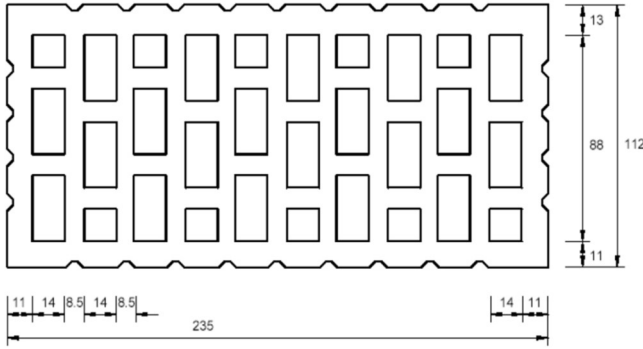

Hollow clay brick HLz 12-1,0-2DF  
 according to EN 771-1  
 length/width/height = 235 mm/112 mm/115 mm  
 $f_b \geq 12 \text{ N/mm}^2 / \rho \geq 1,0 \text{ kg/dm}^3$

**Brick N° 2**

Solid clay brick Mz 12-2,0-NF  
 according to EN 771-1  
 length/width/height = 240 mm/116 mm/71 mm  
 $f_b \geq 12 \text{ N/mm}^2 / \rho \geq 2,0 \text{ kg/dm}^3$

**Brick N° 3**

Solid sand lime brick KS 12-2,0-NF  
 according to EN 771-2  
 length/width/height = 240 mm/115 mm/70 mm  
 $f_b \geq 12 \text{ N/mm}^2 / \rho \geq 2,0 \text{ kg/dm}^3$

**Brick N° 4**

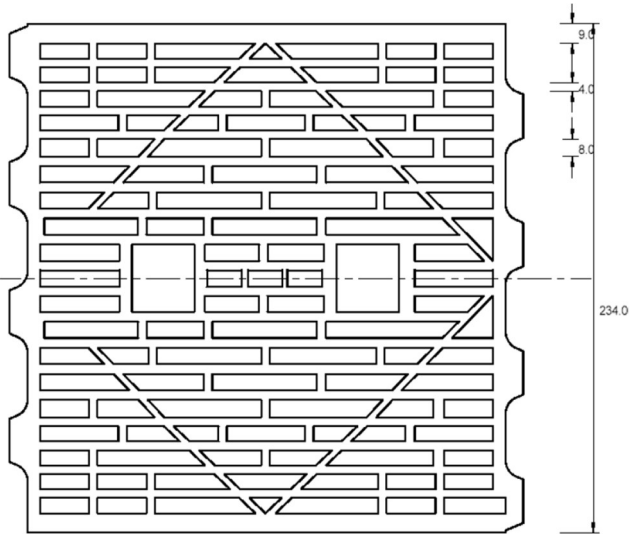

Hollow clay brick HLzW 6-0,7-8DF  
 according to EN 771-1  
 length/width/height = 250 mm/240 mm/240 mm  
 $f_b \geq 6 \text{ N/mm}^2 / \rho \geq 0,8 \text{ kg/dm}^3$

**Brick N° 5**

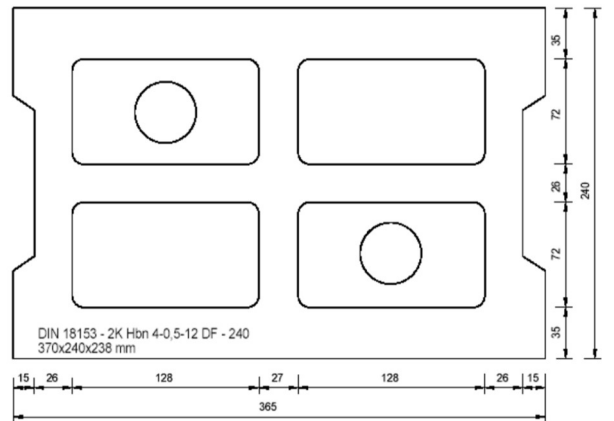

Concrete masonry unit Hbn 4-12DF  
 according to EN 771-3  
 length/width/height = 370 mm/240 mm/238 mm  
 $f_b \geq 4 \text{ N/mm}^2 / \rho \geq 1,2 \text{ kg/dm}^3$

**MO-PUS  
 for masonry**

**Intended use**  
 Brick types and properties

**Annex B 2**

**Table B2: Types and dimensions of block and bricks**

**Brick N° 6**

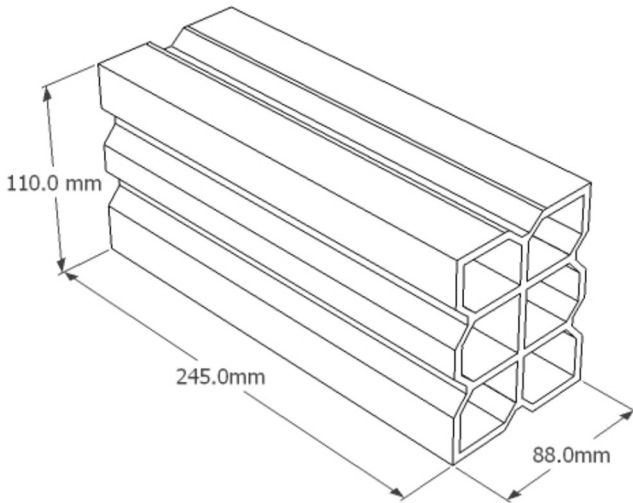

Hollow clay brick Hueco Doble  
 according to EN 771-1  
 length/width/height = 245 mm/110 mm/88 mm  
 $f_b \geq 2,5 \text{ N/mm}^2$  /  $\rho \geq 0,74 \text{ kg/dm}^3$

**Brick N° 7**

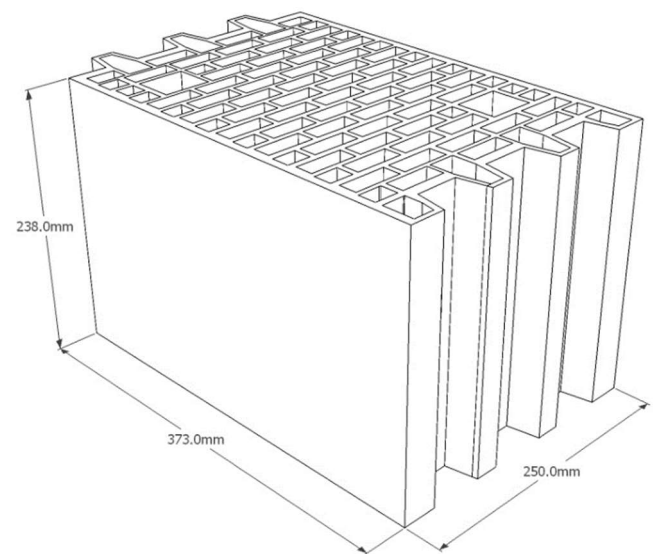

Hollow clay brick Porotherm 25 P+W KL15  
 according to EN 771-1  
 length/width/height = 373 mm/250 mm/238 mm  
 $f_b \geq 12 \text{ N/mm}^2$  /  $\rho \geq 0,9 \text{ kg/dm}^3$

**MO-PUS**  
 for masonry

**Intended use**  
 Brick types and properties

**Annex B 3**

### Applicator gun

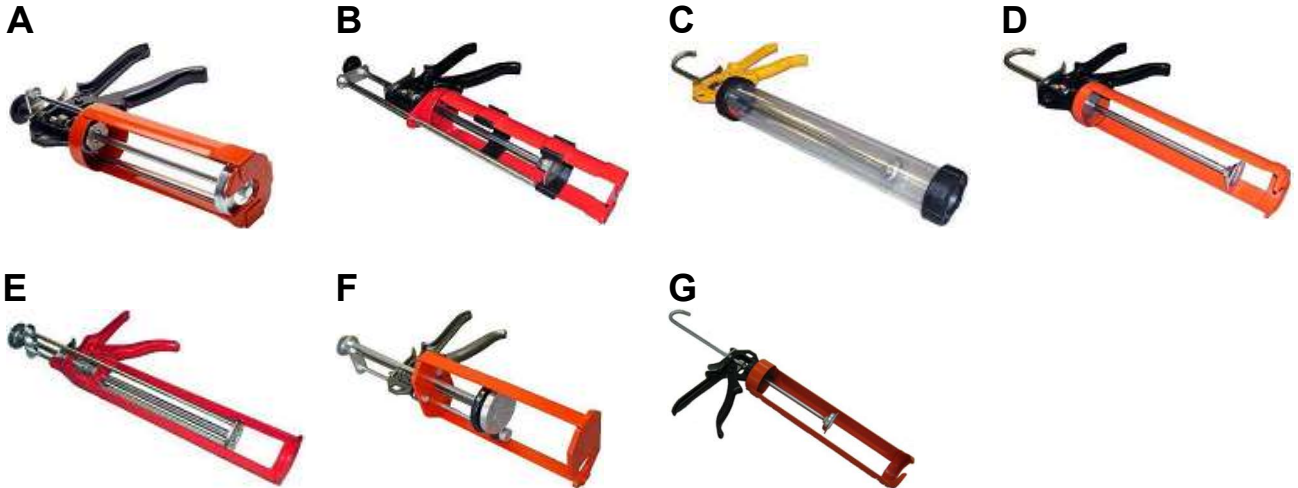

Applicator gun	A	B	C	D	E	F	G
Cartridge	Coaxial 380ml 400ml 410ml	Side by side 350ml	Foil capsule 150ml 300ml 550ml	Foil capsule 150ml 300ml Peeler 280ml	Coaxial 150ml	Side by side 825ml	Foil capsule 850ml

### Cleaning brush

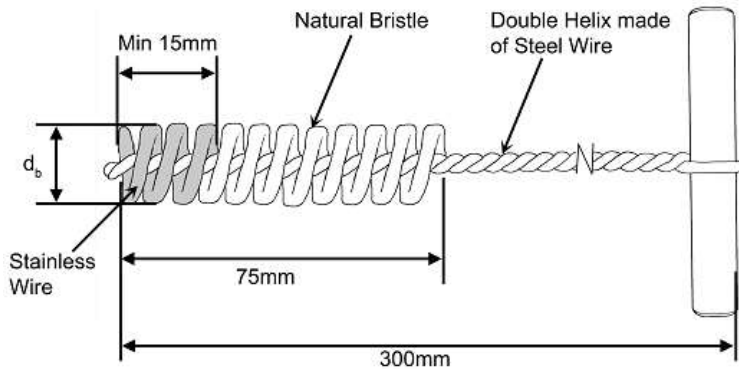

### Cleaning pump

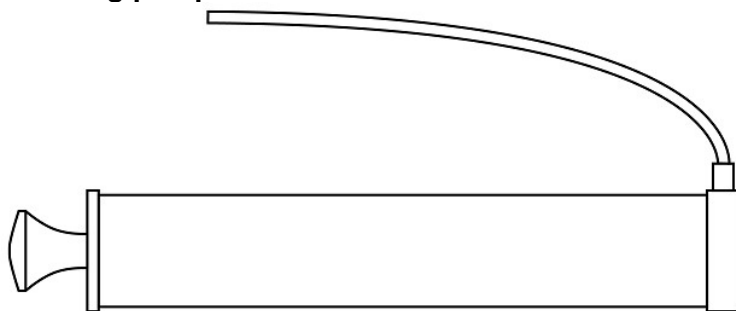







**MO-PUS  
for masonry**

**Intended use**  
Applicator guns  
Cleaning brush, Cleaning pump

**Annex B 4**

## Installation instructions

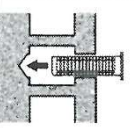
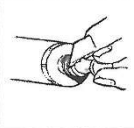
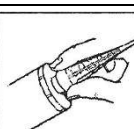
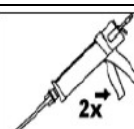
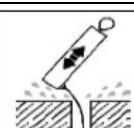
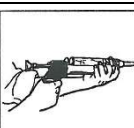
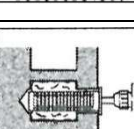
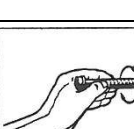
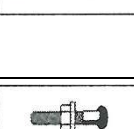
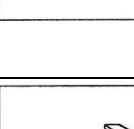
	<p><b>1.</b> Drill the hole to the correct diameter and depth using a rotary percussive machine.</p>		<p><b>2.</b> Use the cleaning pump to clean the hole.</p>
	<p><b>3.</b> Use the cleaning brush to clean the hole. Diameter of Cleaning brush according to Table B4.</p>		<p><b>4.</b> Use the cleaning pump to clean the hole.</p>
	<p><b>5.</b> Use the cleaning brush to clean the hole. Diameter of Cleaning brush according to Table B4.</p>		<p><b>6.</b> Use the cleaning pump to clean the hole.</p>
	<p><b>7.</b> If used in hollow or perforated brick masonry: Plug the centering cap and insert the correct perforated sleeve flush with the surface of the base material.</p>		<p><b>8.</b> Once the hole is prepared, remove the screw cap from the cartridge.</p>
	<p><b>9.</b> Attach the mixer nozzle and place the cartridge in the applicator gun.</p>		<p><b>10.</b> Dispense the first part to waste, until an even colour is achieved.</p>
	<p><b>11.</b> Remove any remaining water from the hole.</p>		<p><b>12.</b> Insert the nozzle to the far end of the hole (using extension tubing if necessary) and inject the resin, withdrawing the nozzle/tube as the hole fills.</p>
	<p><b>13.</b> If used in hollow or perforated brick masonry: Insert mixer nozzle to the end of the perforated sleeve and completely fill the sleeve with resin. Withdraw the mixer nozzle as the sleeve fills.</p>		<p><b>14.</b> Immediately insert the fixing (steel element) slowly and with a slight twisting motion. Remove excess resin from around the mouth of the hole.</p>
	<p><b>15.</b> Leave the fixing undisturbed until the cure time (see Table B6) has elapsed.</p>		<p><b>16.</b> Attach the fixture and tighten the nut. Maximum installation torque moment according to Table B6.</p>

**MO-PUS**  
for masonry

**Intended use**  
Installation instructions

**Annex B 5**

**Table B4: Installation parameters in solid and hollow masonry**

Anchor type		Anchor rod						
		M8		M10		M12		
Size								
Sieve sleeve	$l_s$ [mm]	-	-	-	85		85	
	$d_s$ [mm]	-	-	-	15	16	15	16
Nominal drill hole diameter	$d_0$ [mm]	15	15	20	15	16	15	16
Diameter of cleaning brush	$d_b$ [mm]	$20^{\pm 1}$	$20^{\pm 1}$	$22^{\pm 1}$	$20^{\pm 1}$	$20^{\pm 1}$	$20^{\pm 1}$	$22^{\pm 1}$
Depth of the drill hole	$h_0$ [mm]	90						
Effective anchorage depth	$h_{ef}$ [mm]	85						
Diameter of clearance hole in the fixture	$d_{f \leq}$ [mm]	9	12	14	9	12	12	14
Torque moment	$T_{inst \leq}$ [mm]	2						

**Table B5: Edge distances and spacing**

Base material <sup>1)</sup>	Anchor rod								
	M8			M10			M12		
	$c_{cr} = c_{min}$	$s_{cr \parallel} = s_{min \parallel}$	$s_{cr \perp} = s_{min \perp}$	$c_{cr} = c_{min}$	$s_{cr \parallel} = s_{min \parallel}$	$s_{cr \perp} = s_{min \perp}$	$c_{cr} = c_{min}$	$s_{cr \parallel} = s_{min \parallel}$	$s_{cr \perp} = s_{min \perp}$
[mm]	[mm]	[mm]	[mm]	[mm]	[mm]	[mm]	[mm]	[mm]	[mm]
Brick N° 1	100	235	115	100	235	115	120	235	115
Brick N° 2	128	255	255	128	255	255	128	255	255
Brick N° 3	128	255	255	128	255	255	128	255	255
Brick N° 4	100	250	240	100	250	240	120	250	240
Brick N° 5	100	370	238	100	370	238	120	370	238
Brick N° 6	100	245	110	100	245	110	120	245	110
Brick N° 7	100	373	238	100	373	238	120	373	238

<sup>1)</sup> Brick N° according to Annex B 2 to B 3

**Table B6: Minimum curing time**

Resin cartridge temperature [°C]	T Work [mins]	Base material Temperature [°C]	T Load [mins]
min +5	18	min +5	145
+5 to +10	10	+5 to +10	
+10 to +20	6	+10 to +20	85
+20 to +25	5	+20 to +25	50
+25 to +30	4	+25 to +30	40
+30		+30	35

T work is typical gel time at highest temperature

T load is set at the lowest temperature

**MO-PUS**  
for masonry

Intended use  
Installation parameters  
Working and curing time

**Annex B 6**

**Table C1: Characteristic resistance under tension and shear loading**

Base material	Anchor rods $N_{Rk} = V_{Rk}$ [kN] <sup>1)</sup>		
	M8	M10	M12
Brick N° 1	2,0	2,0	2,0
Brick N° 2	1,2	1,5	2,5
Brick N° 3	0,5	0,75	1,2
Brick N° 4	0,6	0,75	0,75
Brick N° 5	1,2	1,2	2,0
Brick N° 6	0,5	0,5	0,5
Brick N° 7	1,2	1,2	1,5

<sup>1)</sup> For design according TR 054:  $N_{Rk} = N_{Rk,p} = N_{Rk,b} = N_{Rk,s}$ ;  $N_{Rk,pb}$  according to TR 054  
For  $V_{Rk,s}$  see Annex C1, Table C2; Calculation of  $V_{Rk,pb}$  and  $V_{Rk,c}$  according to TR 054

**Table C2: Characteristic bending moment**

Size		M8	M10	M12
Steel grade 5.8	$M_{Rk,s}$ [N.m]	19	37	66
Steel grade 8.8	$M_{Rk,s}$ [N.m]	30	60	105
Steel grade 10.9	$M_{Rk,s}$ [N.m]	37	75	131
Stainless steel grade A2-70, A4-70	$M_{Rk,s}$ [N.m]	26	52	92
Stainless steel grade A4-80	$M_{Rk,s}$ [N.m]	30	60	105
Stainless steel grade 1.4529 strength class 70	$M_{Rk,s}$ [N.m]	26	52	92
Stainless steel grade 1.4565 strength class 70	$M_{Rk,s}$ [N.m]	26	52	92

**Table C3: Displacements under tension and shear load**

Base material	F [kN]	$\delta_{N0}$ [mm]	$\delta_{N\infty}$ [mm]	$\delta_{V0}$ [mm]	$\delta_{V\infty}$ [mm]
Solid bricks	$N_{Rk} / (1,4 \cdot \gamma_M)$	0,6	1,2	1,0 <sup>1)</sup>	1,5 <sup>1)</sup>
Perforated and hollow bricks		0,14	0,28	1,0 <sup>1)</sup>	1,5 <sup>1)</sup>

<sup>1)</sup> the hole gap between bolt and fixture shall be considered additionally

**Table C4:  $\beta$  - factors for job site tests according to TR 053**

Brick N°	N° 1	N° 2	N° 3	N° 4	N° 5	N° 6	N° 7
$\beta$ - factor	0,62	0,48	0,26	0,43	0,60	0,65	0,65

MO-PUS  
for masonry

Performances  
Characteristic resistance, displacement  
 $\beta$ -factors for job site testing under tension load

Annex C 1