

CHARACTERISTICS

- Pilot hole in concrete needed, thread is created by the anchor during the Installation process.
- Use for high loads.
- Assessed for 2 installation depths.
- Use in cracked and non-cracked concrete.
- Comply with guideline VdS CEA 4001:2021-01(07) "Guidelines for sprinklers systems. Planning and installation" Ø8 to Ø12.
- Suitable when reduced edge distances or spacing required.
- Qualified for static or quasi-static and seismic C1 loads.
- Easy installation.
- Installation through the fixture.
- Possibility of installation by drill bit cleaning
- Reusable
- Removable, leaving concrete surface flat.
- Variety of lengths and sizes, assembly flexibility.
- Base material temperature range: -40°C to +80 °C
- Available in INDEXcal

BASE MATERIAL



SIZE RANGE

Ø6 - Ø12

DRILL CONDITION

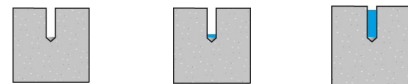

SECO HUMEDO INUNDADO

MAXIMUM LOADS RECOMMENDED FOR CRACKED AND UNCRACKED CONCRETE [kg]

APPLICATION





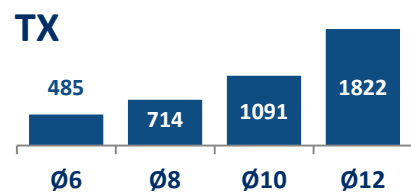







ASSESSMENTS

- Structural fixings in cracked and uncracked concrete for indoor and outdoor conditions.
- Glazing, windows and storefronts
- Racking and shelving
- Attaching railings, handrails and ledgers
- Fixings wood structures in concrete



APPLICATION EXAMPLES



1. RANGE						
ITEM	CODE	SIZES	PHOTO	DESCRIPTION	MATERIAL	COVERING
1	TXE	Ø6 - Ø12		Hexagonal head with flange screw anchor	Stainless steel A4	
2	TXA	Ø6 - Ø10		Countersunk head	Stainless steel A4	
3	TXT	Ø6		"Truss" head	Stainless steel A4	
4	TXP	Ø6 - Ø8		"Pan" head	Stainless steel A4	
5	TXF	Ø6		Rod hanger internal thread	Stainless steel A4	
6	TXD	Ø6 - Ø12		"Dome" head	Stainless steel A4	

2. INSTALLATION DATA

2.1. INSTALLATION DRAWING

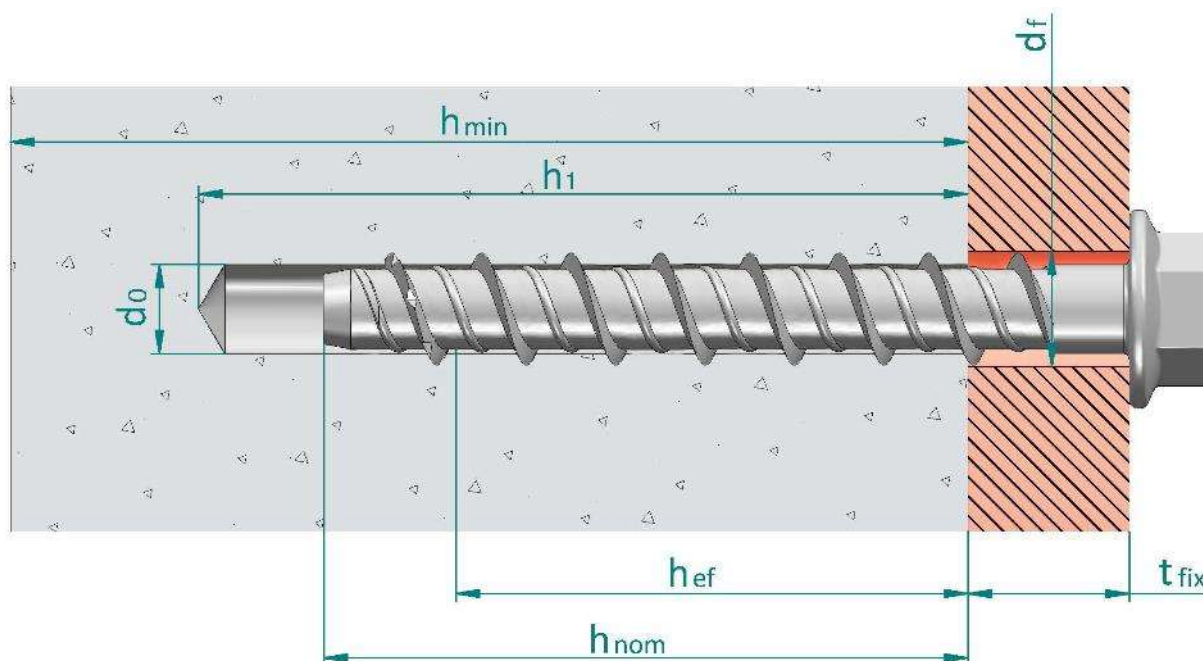

- d_0 : Nominal diameter of drill bit
- d_f : Fixture clearance hole diameter
- h_{ef} : Effective anchorage depth
- h_1 : Depth of drilled hole
- h_{nom} : Overall fastener embedment depth in the concrete
- h_{min} : Minimum thickness of concrete member
- t_{fix} : Fixture thickness

2.2. SEISMIC LOAD ASSESSMENT

Family	Code	Size	Assessed	C1	C2
[--]	[--]	[--]	ETA	[--]	[--]
TXE	TXE06040	Ø6 x 40	✓	--	--
	TXE06060	Ø6 x 60	✓	✓	--
	TXE08070	Ø8 x 70	✓	✓	--
	TXE08080	Ø8 x 80	✓	✓	--
	TXE08090	Ø8 x 90	✓	✓	--
	TXE08105	Ø8 x 105	✓	✓	--
	TXE10070	Ø10 x 70	✓	✓	--
	TXE10090	Ø10 x 90	✓	✓	--
	TXE10100	Ø10 x 100	✓	✓	--
	TXE10120	Ø10 x 120	✓	✓	--
	TXE12080	Ø12 x 80	✓	✓	--
TXE12110	Ø12 x 110	✓	✓	--	
TXA	TXA06050	Ø6 x 50	✓	--	--
	TXA06060	Ø6 x 60	✓	✓	--
	TXA06080	Ø6 x 80	✓	✓	--
	TXA06100	Ø6 x 100	✓	✓	--
	TXA08060	Ø8 x 60	✓	✓	--
	TXA08080	Ø8 x 80	✓	✓	--
	TXA08120	Ø8 x 120	✓	✓	--
	TXA10070	Ø10 x 70	✓	✓	--
	TXA10090	Ø10 x 90	✓	✓	--
TXA10120	Ø10 x 120	✓	✓	--	
TXT	TXT06040	Ø6 x 40	✓	--	--
	TXT06050	Ø6 x 50	✓	--	--
	TXT06060	Ø6 x 60	✓	✓	--
	TXT06080	Ø6 x 80	✓	✓	--
	TXT06100	Ø6 x 100	✓	✓	--
TXP	TXP06050	Ø6 x 50	✓	--	--
	TXP06060	Ø6 x 60	✓	✓	--
	TXP06080	Ø6 x 80	✓	✓	--
	TXP06100	Ø6 x 100	✓	✓	--
	TXP08060	Ø8 x 60	✓	✓	--
TXP08080	Ø8 x 80	✓	✓	--	
TXF	TXF06040C	Ø6 x 40 (M8-M10)	✓	--	--
TXD	TXD06050	Ø6 x 50	✓	--	--
	TXD08075	Ø8 x 75	✓	✓	--
	TXD10075	Ø10 x 75	✓	✓	--
	TXD12100	Ø12 x 100	✓	✓	--

3. INSTALLATION PARAMETERS

General Installation parameters				Standard Installation depth ($h_{ef, std}$)													Reduced Installation depth ($h_{ef, red}$)										
Family	Code	Size	Assessed	Drill bit diameter	Fixture clearance hole	Spanner	Maximum torque	Minimum allowable spacing	Minimum allowable edge distance	Minimum concrete thickness	Depth of drill hole/ Depth for drill bit cleaning	Installation depth	Effective anchorage depth	Thickness of fixture	Critical spacing (concrete cone)	Critical edge distance (cone)	Critical spacing (splitting)	Critical edge distance (splitting)	Minimum concrete thickness	Depth of drill hole/ Depth for drill bit cleaning	Installation depth	Effective anchorage depth	Thickness of fixture	Critical spacing (concrete cone)	Critical edge distance (cone)	Critical spacing (splitting)	Critical edge distance (splitting)
[--]	[--]	[--]	ETA	d_0 [mm]	d_f [mm]	SW/Tx [--]	T_{inst} [Nm]	S_{min} [mm]	C_{min} [mm]	h_{min} [mm]	$h_1/h_{1,bit}$ [mm]	h_{nom} [mm]	h_{ef} [mm]	t_{fix} [mm]	$S_{cr,N}$ [mm]	$C_{cr,N}$ [mm]	$S_{cr,sp}$ [mm]	$C_{cr,sp}$ [mm]	h_{min} [mm]	$h_1/h_{1,bit}$ [mm]	h_{nom} [mm]	h_{ef} [mm]	t_{fix} [mm]	$S_{cr,N}$ [mm]	$C_{cr,N}$ [mm]	$S_{cr,sp}$ [mm]	$C_{cr,sp}$ [mm]
TXE	TXE06040	Ø6 x 40	✓	6	7,5 - 9	SW 10	10	35	35	--	--	--	--	--	--	--	--	--	80	45/57	35	26,0	5	78	39	90	45
	TXE06060	Ø6 x 60	✓							25																	
	TXE08070	Ø8 x 70	✓	8	10,1 - 12	SW 13	20	35	35	80	75/91	65	50,5	5	152	76	220	110	80	60/76	50	37,5	20	113	57	130	65
	TXE08080	Ø8 x 80	✓							30																	
	TXE08090	Ø8 x 90	✓							40																	
	TXE08105	Ø8 x 105	✓							55																	
	TXE10070	Ø10 x 70	✓	10	12,3 - 14	SW 15	30	50	40	--	--	--	--	--	--	--	--	--	80	65/85	55	41,5	15	125	63	140	70
	TXE10090	Ø10 x 90	✓							35																	
	TXE10100	Ø10 x 100	✓							45																	
	TXE10120	Ø10 x 120	✓							65																	
	TXE12080	Ø12 x 80	✓	12	14,4 - 16	SW 18	50	75	45	--	--	--	--	--	--	--	--	--	90	90/114	75	58,0	5	174	87	190	95
TXE12110	Ø12 x 110	✓	35																								
TXA	TXA06050	Ø6 x 50	✓	6	7,5 - 9	TX30	10	35	35	--	--	--	--	--	--	--	--	--	80	45/57	35	26,0	15	78	39	90	45
	TXA06060	Ø6 x 60	✓							25																	
	TXA06080	Ø6 x 80	✓							45																	
	TXA06100	Ø6 x 100	✓							65																	
	TXA08060	Ø8 x 60	✓	8	10,1 - 12	TX45	20	35	35	--	--	--	--	--	--	--	--	--	80	60/76	50	37,5	10	113	57	130	65
	TXA08080	Ø8 x 80	✓							30																	
	TXA08120	Ø8 x 120	✓							40																	
	TXA10070	Ø10 x 70	✓							15																	
TXA10090	Ø10 x 90	✓	10	12,3 - 14	TX50	30	50	40	--	--	--	--	--	--	--	--	--	80	65/85	55	41,5	35	125	63	140	70	
TXA10120	Ø10 x 120	✓							65																		
TXA10120	Ø10 x 120	✓							65																		
TXT	TXT06040	Ø6 x 40	✓	6	7,5 - 9	TX30	10	35	35	--	--	--	--	--	--	--	--	--	80	45/57	35	26,0	5	78	39	90	45
	TXT06050	Ø6 x 50	✓							15																	
	TXT06060	Ø6 x 60	✓							25																	
	TXT06080	Ø6 x 80	✓							45																	
	TXT06100	Ø6 x 100	✓							65																	

General Installation parameters										Standard Installation depth ($h_{ef, std}$)								Reduced Installation depth ($h_{ef, red}$)									
Family	Code	Size	Assessed	Drill bit diameter	Fixture clearance hole	Spanner	Maximum torque	Minimum allowable spacing	Minimum allowable edge distance	Minimum concrete thickness	Depth of drill hole/ Depth for drill bit cleaning	Installation depth	Effective anchorage depth	Thickness of fixture	Critical spacing (concrete cone)	Critical edge distance (cone)	Critical spacing (splitting)	Critical edge distance (splitting)	Minimum concrete thickness	Depth of drill hole/ Depth for drill bit cleaning	Installation depth	Effective anchorage depth	Thickness of fixture	Critical spacing (concrete cone)	Critical edge distance (cone)	Critical spacing (splitting)	Critical edge distance (splitting)
[--]	[--]	[--]	ETA	d_0 [mm]	d_f [mm]	SW/Tx [--]	T_{inst} [Nm]	S_{min} [mm]	C_{min} [mm]	h_{min} [mm]	$h_1/h_{1,bit}$ [mm]	h_{nom} [mm]	h_{ef} [mm]	t_{fix} [mm]	$S_{cr,N}$ [mm]	$C_{cr,N}$ [mm]	$S_{cr,sp}$ [mm]	$C_{cr,sp}$ [mm]	h_{min} [mm]	$h_1/h_{1,bit}$ [mm]	h_{nom} [mm]	h_{ef} [mm]	t_{fix} [mm]	$S_{cr,N}$ [mm]	$C_{cr,N}$ [mm]	$S_{cr,sp}$ [mm]	$C_{cr,sp}$ [mm]
TXP	TXP06050	Ø6 x 50	✓	6	7,5 - 9	TX40	10	35	35	--	--	--	--	--	--	--	--	--	80	45/57	35	26,0	5	78	39	90	45
	TXP06060	Ø6 x 60	✓							15																	
	TXP06080	Ø6 x 80	✓							25	129	65	190	95	35	35											
	TXP06100	Ø6 x 100	✓							45																	
	TXP08060	Ø8 x 60	✓	8	10,1 - 12	TX45	20	35	35	80	75/91	65	50,5	5	152	76	220	110	80	60/76	50	37,5	20	113	57	130	65
TXP08080	Ø8 x 80	✓	25							40	40	40	40	40	40	40	40	40					40				
TXF	TXF06040C	Ø6 x 40 (M8-M10)	✓	6	--	SW 13	10	35	35	--	--	--	--	--	--	--	--	--	80	45/57	35	26,0	5	78	39	90	45
TXD	TXD06050	Ø6 x 50	✓	6	7,5 - 9	SW 10	10	35	35	--	--	--	--	--	--	--	--	--	80	45/57	35	26,0	15	78	39	90	45
	TXD08075	Ø8 x 75	✓	8	10,1 - 12	SW 13	20	35	35	80	75/91	65	50,5	10	152	76	220	110	80	60/76	50	37,5	25	113	57	130	65
	TXD10075	Ø10 x 75	✓	10	12,3 - 14	SW 15	30	50	40	--	--	--	--	--	--	--	--	--	80	65/85	55	41,5	20	125	63	140	70
	TXD12100	Ø12 x 100	✓	12	14,4 - 16	SW 18	50	75	45	--	--	--	--	--	--	--	--	--	120	90/114	75	58,0	25	174	87	190	95

4. INSTALLATION PROCEDURE

4.1. CONCRETE INSTALLATION

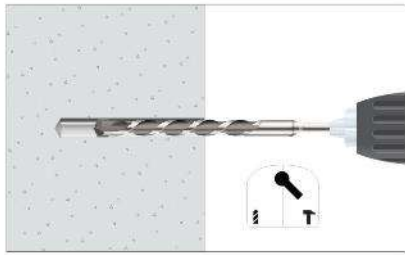

1. DRILLING

Check the concrete is well compacted and without significant porosity. Suitable for dry, wet and flooded holes. Use drill in hammer mode. Drill according to specified depths in previous tables.



2. BLOW AND CLEAN

Clean the hole from dust and concrete remains. Use blow pump and brush.

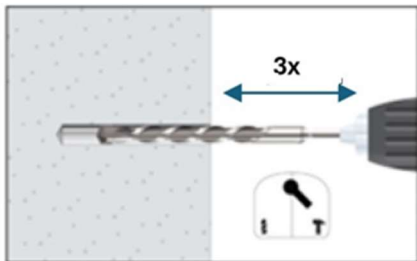

2. b) CLEAN WITH DRILL BIT

Alternatively, to 2.a):

- Upward installation direction: no cleaning is needed.
- Downward or horizontal installation direction: no cleaning is needed if drilling depth is h_1 , bit, and after the drilling process the drill bit is moved in and out of the hole for 3 times with both rotary and hammer modes of the drilling machine activated.

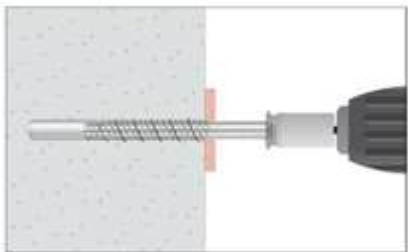

3. INSTALL

Select a powered impact wrench or a torque wrench that does not exceed the maximum torque indicated in previous tables. Attach an appropriate size hex socket to the wrench. Mount the screw anchor head in the socket.

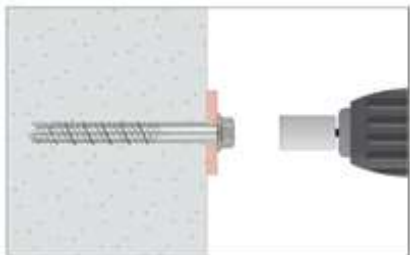

4. APPLY THE TORQUE

Drive the anchor with an impact driver or a torque wrench through the fixture and into the hole until the anchor head washer comes in contact with the fixture. The anchor must be snug after installation. Do not spin the hex socket off the anchor to disengage.

5. RESISTANCES

Resistances in concrete class C20/25 for an isolated anchor without spacing or concrete edge distance effects are indicated in the following table:

Values underlined and in italics show Steel failure, **bold** values concrete failure and other indicate pull out failure.
1 KN ≈ 100 kg

5.1 CHARACTERISTIC RESISTANCE (STRUCTURAL APPLICATIONS) [kN]

General Parameter				Non-cracked concrete				Cracked concrete			
Family	Code	Size	ETA Assessed	Tension $N_{Rk, ucr}$		Shear $V_{Rk, ucr}$		Tension $N_{Rk, cr}$		Shear $V_{Rk, cr}$	
				($h_{ef, std}$)	($h_{ef, red}$)	($h_{ef, std}$)	($h_{ef, red}$)	($h_{ef, std}$)	($h_{ef, red}$)	($h_{ef, std}$)	($h_{ef, red}$)
TXE	TXE06040	Ø6 x 40	✓	--	5,50	--	<u>8,79</u>	--	1,00	--	8,54
	TXE06060	Ø6 x 60	✓	12,00	5,50	<u>8,79</u>	<u>8,79</u>	7,50	1,00	10,20	8,54
	TXE08070	Ø8 x 70	✓	17,65	10,00	<u>14,65</u>	<u>14,65</u>	12,36	5,00	17,18	13,52
	TXE08080	Ø8 x 80	✓								
	TXE08090	Ø8 x 90	✓								
	TXE08105	Ø8 x 105	✓								
	TXE10070	Ø10 x 70	✓	--	13,15	--	24,07	--	9,21	--	16,85
	TXE10090	Ø10 x 90	✓	26,98	13,15	<u>24,06</u>	24,07	18,89	9,21	<u>24,06</u>	16,85
	TXE10100	Ø10 x 100	✓								
	TXE10120	Ø10 x 120	✓								
	TXE12080	Ø12 x 80	✓	--	21,73	--	<u>34,84</u>	--	14,10	--	33,31
TXE12110	Ø12 x 110	✓	37,54	21,73	<u>34,84</u>	<u>34,84</u>	26,27	14,10	<u>34,84</u>	33,31	
TXA	TXA06050	Ø6 x 50	✓	--	5,50	--	<u>8,79</u>	--	1,00	--	8,54
	TXA06060	Ø6 x 60	✓	12,00	5,50	<u>8,79</u>	<u>8,79</u>	7,50	1,00	10,20	8,54
	TXA06080	Ø6 x 80	✓								
	TXA06100	Ø6 x 100	✓								
	TXA08060	Ø8 x 60	✓	--	10,00	--	<u>14,65</u>	--	5,00	--	13,52
	TXA08080	Ø8 x 80	✓	17,65	10,00	<u>14,65</u>	<u>14,65</u>	12,36	5,00	17,18	13,52
	TXA08120	Ø8 x 120	✓								
	TXA10070	Ø10 x 70	✓	--	13,15	--	24,07	--	9,21	--	16,85
	TXA10090	Ø10 x 90	✓	26,98	13,15	<u>24,06</u>	24,07	18,89	9,21	<u>24,06</u>	16,85
TXA10120	Ø10 x 120	✓									
TXT	TXT06040	Ø6 x 40	✓	--	5,50	--	<u>8,79</u>	--	1,00	--	8,54
	TXT06050	Ø6 x 50	✓	12,00	5,50	<u>8,79</u>	<u>8,79</u>	7,50	1,00	10,20	8,54
	TXT06060	Ø6 x 60	✓								
	TXT06080	Ø6 x 80	✓								
	TXT06100	Ø6 x 100	✓								
TXP	TXP06050	Ø6 x 50	✓	--	5,50	--	<u>8,79</u>	--	1,00	--	8,54
	TXP06060	Ø6 x 60	✓	12,00	5,50	<u>8,79</u>	<u>8,79</u>	7,50	1,00	10,20	8,54
	TXP06080	Ø6 x 80	✓								
	TXP06100	Ø6 x 100	✓								
	TXP08060	Ø8 x 60	✓	--	10,00	--	<u>14,65</u>	--	5,00	--	13,52
	TXP08080	Ø8 x 80	✓	17,65	10,00	<u>14,65</u>	<u>14,65</u>	12,36	5,00	17,18	13,52
TXF	TXF06040C	Ø6 x 40 (M8-M10)	✓	--	5,50	--	--	--	1,00	--	--
TXD	TXD06050	Ø6 x 50	✓	--	5,50	--	<u>8,79</u>	--	1,00	--	8,54
	TXD08075	Ø8 x 75	✓	17,65	10,00	<u>14,65</u>	<u>14,65</u>	12,36	5,00	17,18	13,52
	TXD10075	Ø10 x 75	✓	--	13,15	--	24,07	--	9,21	--	16,85
	TXD12100	Ø12 x 100	✓	--	21,73	--	<u>34,84</u>	--	14,10	--	33,31

5.2 DESIGN RESISTANCE (STRUCTURAL APPLICATIONS) [kN]

General Parameter				Non-cracked concrete				Cracked concrete			
Family	Code	Size	ETA Assessed	Tension $N_{Rd,ucr}$		Shear $V_{Rd,ucr}$		Tension $N_{Rd,cr}$		Shear $V_{Rd,cr}$	
				($h_{ef,sta}$)	($h_{ef,red}$)	($h_{ef,sta}$)	($h_{ef,red}$)	($h_{ef,sta}$)	($h_{ef,red}$)	($h_{ef,sta}$)	($h_{ef,red}$)
TXE	TXE06040	Ø6 x 40	✓	--	3,06	--	<u>7,03</u>	--	0,56	--	5,69
	TXE06060	Ø6 x 60	✓	6,67	3,06	<u>7,03</u>	<u>7,03</u>	4,17	0,56	6,80	5,69
	TXE08070	Ø8 x 70	✓	9,81	5,56	<u>11,72</u>	<u>11,72</u>	6,87	2,78	11,45	9,01
	TXE08080	Ø8 x 80	✓								
	TXE08090	Ø8 x 90	✓								
	TXE08105	Ø8 x 105	✓	--	7,31	--	16,04	--	5,11	--	11,23
	TXE10070	Ø10 x 70	✓	14,99	7,31	<u>19,25</u>	16,04	10,49	5,11	<u>19,25</u>	11,23
	TXE10090	Ø10 x 90	✓								
	TXE10100	Ø10 x 100	✓								
	TXE10120	Ø10 x 120	✓	--	12,07	--	<u>27,87</u>	--	7,83	--	22,21
TXE12080	Ø12 x 80	✓	25,02	12,07	<u>27,87</u>	<u>27,87</u>	17,52	7,83	<u>27,87</u>	22,21	
TXE12110	Ø12 x 110	✓	--	3,06	--	<u>7,03</u>	--	0,56	--	5,69	
TXA	TXA06050	Ø6 x 50	✓	6,67	3,06	<u>7,03</u>	<u>7,03</u>	4,17	0,56	6,80	5,69
	TXA06060	Ø6 x 60	✓								
	TXA06080	Ø6 x 80	✓								
	TXA06100	Ø6 x 100	✓	--	5,56	--	--	--	2,78	--	9,01
	TXA08060	Ø8 x 60	✓	9,81	5,56	<u>11,72</u>	<u>11,72</u>	6,87	2,78	11,45	9,01
	TXA08080	Ø8 x 80	✓								
	TXA08120	Ø8 x 120	✓								
	TXA10070	Ø10 x 70	✓	--	7,31	--	16,04	--	5,11	--	11,23
	TXA10090	Ø10 x 90	✓	14,99	7,31	<u>19,25</u>	16,04	10,49	5,11	<u>19,25</u>	11,23
TXA10120	Ø10 x 120	✓									
TXT	TXT06040	Ø6 x 40	✓	--	3,06	--	<u>7,03</u>	--	0,56	--	5,69
	TXT06050	Ø6 x 50	✓	6,67	3,06	<u>7,03</u>	<u>7,03</u>	4,17	0,56	6,80	5,69
	TXT06060	Ø6 x 60	✓								
	TXT06080	Ø6 x 80	✓								
	TXT06100	Ø6 x 100	✓	--	3,06	--	<u>7,03</u>	--	0,56	--	5,69
TXP	TXP06050	Ø6 x 50	✓	6,67	3,06	<u>7,03</u>	<u>7,03</u>	4,17	0,56	6,80	5,69
	TXP06060	Ø6 x 60	✓								
	TXP06080	Ø6 x 80	✓								
	TXP06100	Ø6 x 100	✓	--	5,56	--	<u>11,72</u>	--	2,78	--	9,01
	TXP08060	Ø8 x 60	✓	9,81	5,56	<u>11,72</u>	<u>11,72</u>	6,87	2,78	11,45	9,01
	TXP08080	Ø8 x 80	✓								
TXF	TXF06040C	Ø6 x 40 (M8-M10)	✓	--	3,06	--	--	--	0,56	--	--
TXD	TXD06050	Ø6 x 50	✓	--	3,06	--	<u>7,03</u>	--	0,56	--	5,69
	TXD08075	Ø8 x 75	✓	9,81	5,56	<u>11,72</u>	<u>11,72</u>	6,87	2,78	11,45	9,01
	TXD10075	Ø10 x 75	✓	--	7,31	--	16,04	--	5,11	--	11,23
	TXD12100	Ø12 x 100	✓	--	12,07	--	<u>27,87</u>	--	7,83	--	22,21

5.3 MAXIMUM LOADS RECOMMENDED (STRUCTURAL APPLICATIONS) [kN] (with $\gamma_F= 1.4$)

General Parameter				Non-cracked concrete				Cracked concrete			
Family	Code	Size	ETA Assessed	Tension $N_{rec,ucr}$		Shear $V_{rec,ucr}$		Tension $N_{rec,cr}$		Shear $V_{rec,cr}$	
				($h_{ef, std}$)	($h_{ef, red}$)	($h_{ef, std}$)	($h_{ef, red}$)	($h_{ef, std}$)	($h_{ef, red}$)	($h_{ef, std}$)	($h_{ef, red}$)
TXE	TXE06040	Ø6 x 40	✓	--	2,18	--	<u>5,02</u>	--	0,40	--	4,07
	TXE06060	Ø6 x 60	✓	4,76	2,18	<u>5,02</u>	<u>5,02</u>	2,98	0,40	4,85	4,07
	TXE08070	Ø8 x 70	✓	7,01	3,97	<u>8,37</u>	<u>8,37</u>	4,90	1,98	8,18	6,44
	TXE08080	Ø8 x 80	✓								
	TXE08090	Ø8 x 90	✓								
	TXE08105	Ø8 x 105	✓	--	5,22	--	11,46	--	3,65	--	8,02
	TXE10070	Ø10 x 70	✓	10,71	5,22	<u>13,75</u>	11,46	7,49	3,65	<u>13,75</u>	8,02
	TXE10090	Ø10 x 90	✓								
	TXE10100	Ø10 x 100	✓								
	TXE10120	Ø10 x 120	✓	--	8,62	--	<u>19,91</u>	--	5,60	--	15,86
TXE12080	Ø12 x 80	✓	17,87	8,62	<u>19,91</u>	<u>19,91</u>	12,51	5,60	<u>19,91</u>	15,86	
TXE12110	Ø12 x 110	✓									
TXA	TXA06050	Ø6 x 50	✓	--	2,18	--	<u>5,02</u>	--	0,40	--	4,07
	TXA06060	Ø6 x 60	✓	4,76	2,18	<u>5,02</u>	<u>5,02</u>	2,98	0,40	4,85	4,07
	TXA06080	Ø6 x 80	✓								
	TXA06100	Ø6 x 100	✓								
	TXA08060	Ø8 x 60	✓	--	3,97	--	<u>8,37</u>	--	1,98	--	6,44
	TXA08080	Ø8 x 80	✓	7,01	3,97	<u>8,37</u>	<u>8,37</u>	4,90	1,98	8,18	6,44
	TXA08120	Ø8 x 120	✓								
	TXA10070	Ø10 x 70	✓	--	5,22	--	11,46	--	3,65	--	8,02
	TXA10090	Ø10 x 90	✓	10,71	5,22	<u>13,75</u>	11,46	7,49	3,65	<u>13,75</u>	8,02
TXA10120	Ø10 x 120	✓									
TXT	TXT06040	Ø6 x 40	✓	--	2,18	--	<u>5,02</u>	--	0,40	--	4,07
	TXT06050	Ø6 x 50	✓	4,76	2,18	<u>5,02</u>	<u>5,02</u>	2,98	0,40	4,85	4,07
	TXT06060	Ø6 x 60	✓								
	TXT06080	Ø6 x 80	✓								
	TXT06100	Ø6 x 100	✓	--	2,18	--	<u>5,02</u>	--	0,40	--	4,07
TXP	TXP06050	Ø6 x 50	✓	4,76	2,18	<u>5,02</u>	<u>5,02</u>	2,98	0,40	4,85	4,07
	TXP06060	Ø6 x 60	✓								
	TXP06080	Ø6 x 80	✓								
	TXP06100	Ø6 x 100	✓	--	3,97	--	<u>8,37</u>	--	1,98	--	6,44
	TXP08060	Ø8 x 60	✓	7,01	3,97	<u>8,37</u>	<u>8,37</u>	4,90	1,98	8,18	6,44
	TXP08080	Ø8 x 80	✓								
TXF	TXF06040C	Ø6 x 40 (M8-M10)	✓	--	2,18	--	--	--	0,40	--	--
TXD	TXD06050	Ø6 x 50	✓	--	2,18	--	<u>5,02</u>	--	0,40	--	4,07
	TXD08075	Ø8 x 75	✓	7,01	3,97	<u>8,37</u>	<u>8,37</u>	4,90	1,98	8,18	6,44
	TXD10075	Ø10 x 75	✓	--	5,22	--	11,46	--	3,65	--	8,02
	TXD12100	Ø12 x 100	✓	--	8,62	--	<u>19,91</u>	--	5,60	--	15,86

PULL OUT INCREASING FACTOR FOR TENSION LOADS IN HIGH RESISTANCE CONCRETE ψ_c

Diameter	Ø6		Ø8		Ø10		Ø12	
Installation depth	($h_{ef, red}$)	($h_{ef, std}$)	($h_{ef, red}$)	($h_{ef, std}$)	($h_{ef, 1}$)	($h_{ef, 3}$)	($h_{ef, red}$)	($h_{ef, std}$)
C30/37	1,12	1,06	1,10	1,08	1,08	1,08	1,10	1,08
C40/50	1,21	1,10	1,17	1,15	1,14	1,14	1,18	1,15
C50/60	1,29	1,14	1,23	1,19	1,19	1,18	1,25	1,19

6. OFFICIAL DOCUMENTATION

The following documents are available on our official website www.indexfix.com:

- European assessment ETA 20/0046 for Installation in cracked and non-cracked concrete according to guideline EAD 330232-02-0601, option 1, from $\varnothing 6$ to $\varnothing 12$.
- Declaration of performance DoP THE.
- VdS certificate CEA 4001:2021-01(07) *Guidelines for sprinklers systems. Planning and installation for applications of water extinguishing systems on concrete elements* from $\varnothing 8$ to $\varnothing 12$.
- Available in the anchor design software INDEXcal.