



GP - X



SP - X



SP - HX



PR - X



SP - RX



SP - UX



### CHARACTERISTICS

- Indextrut channel range: pre galvanized channels for heavy duty fluid piping.
- Great flexibility in assembly: suspended, directly fixed to walls, fixed to other perforated channels, etc.
- Compatible with the clamp range from the catalogue, both for piping and electrical needs.
- Ideal for specialized installers in this field.

### BASE MATERIAL



APPLICATION EXAMPLES



















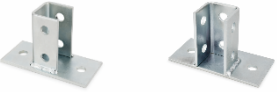

Channels and cantilevers for electrical and telecommunication installations and piping.

Cable tray Cantilevers.

Accessories which complement basic equipment.

## 1. RANGE

ITEM	PHOTO	REFERENCE	DESCRIPTION	MATERIAL	COATING
1		GPX412115	Channel 41 x 21 x 1.50	 Steel	 Atlantis C2-H ≥ 15µm (x̄ = 20 µm)
		GPX412120	Channel 41 x 21 x 2.00		
		GPX412125	Channel 41 x 21 x 2.50		
		GPX414115	Channel 41 x 41 x 1.50		
		GPX414120	Channel 41 x 41 x 2.00		
		GPX414125	Channel 41 x 41 x 2.50		
		GPX2M412120	Channel 41 x 21 x 2.00		
		GPX2M414120	Channel 41 x 41 x 2.00		
2		SPX412115	Cantilever 41 x 21 x 2.50 x 150	 Steel	 Zinc-plated ≥ 5µm
		SPX412130	Cantilever 41 x 21 x 2.50 x 300		
		SPX412145	Cantilever 41 x 21 x 2.50 x 450		
		SPX414115	Cantilever 41 x 41 x 2.50 x 150		
		SPX414130	Cantilever 41 x 41 x 2.50 x 300		
		SPX414145	Cantilever 41 x 41 x 2.50 x 450		
		SPX414160	Cantilever 41 x 41 x 2.50 x 600		
		SPX414175	Cantilever 41 x 41 x 2.50 x 750		
SPX414110	Cantilever 41 x 41 x 2.50 x 1000				
3		SPGH3840	Horizontal channel support	 Steel	 Zinc-plated ≥ 5µm
4		PRX01	Adjustable support Indextrut	 Steel	 Zinc-plated ≥ 5µm
5		SPRXH4121	Rectangular U base support Indextrut	 Steel	 Zinc-plated ≥ 5µm
		SPRXV4121			
6		SPUX412100	support U base Indextrut	 Steel	 Zinc-plated ≥ 5µm
		SPUX412145			



### 3. INSTALLATION DATA

#### 3.1 GP-X

#### Indextrut slotted channel



##### Material



Steel

##### Coating



Atlantis C2-H  
≥ 15µm (x̄ = 20 µm)

#### Installation Data

Code	A1	A2	B	C	ØD	E	F	G	H	L1	L2	L3
GPX412115	41	21	1,5	7	14	22,3	10	30	50	3000	100	20
GPX412120			2,0									
GPX412125			2,5									
GPX414115		41	41							1,5		
GPX414120										2,0		
GPX414125		2,5										
GPX2M412120		21	2,0							2000		
GPX2M414120		41	2,0									

#### Drawing

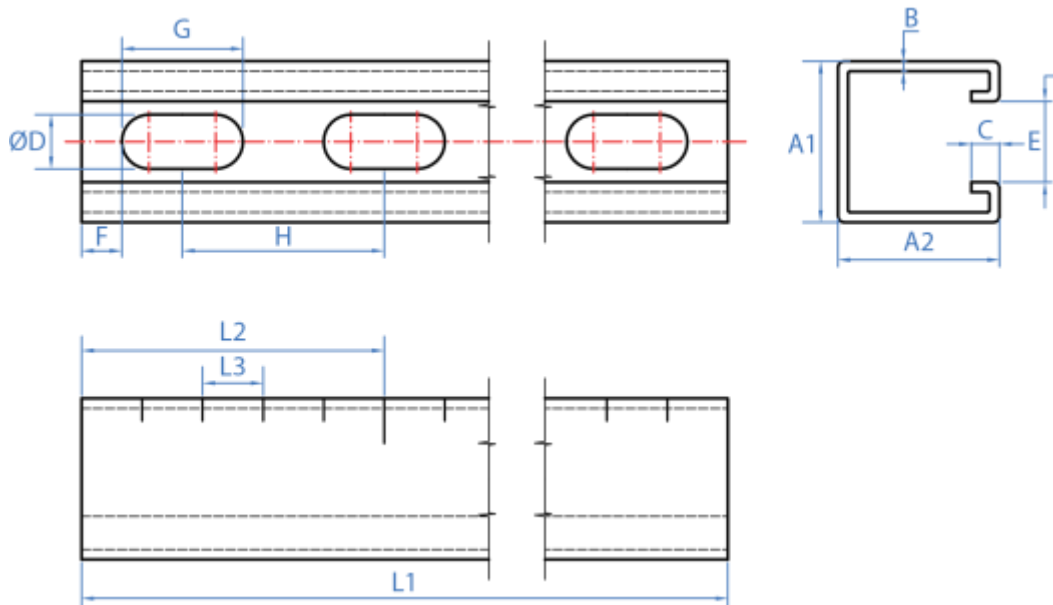

#### Resistances

Check section 5. LOADS AND DESIGN HYPOTHESIS

**3.2 SP-X**

**Indextrut perforated cantilever**



Material	Coating
	
Steel	Zinc-plated

**Installation Data**

Code	A1	A2	B1	B2	C	ØD	Ød1	Ød2	E	F	G1	G2	H	L1	L2	L3
SPX412115		21												150	70	110
SPX412130														300		
SPX412145														450		
SPX414115	41	41	2,5	5	7	14	13	10	22,3	10	30	22	50	150	90	132
SPX414130														300		
SPX414145														450		
SPX414160														600		
SPX414175														750		
SPX414110														1000		

**Drawing**

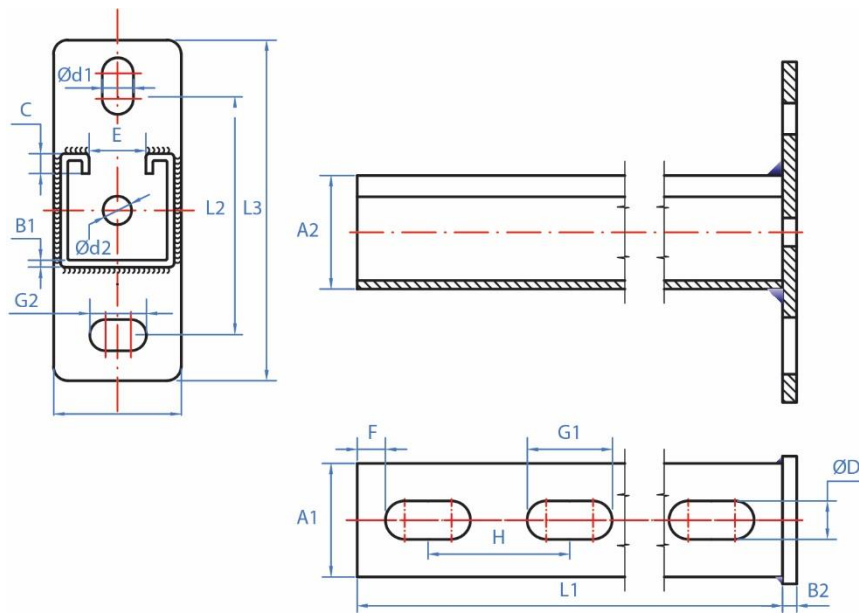

**Resistances**

Check section 5. LOADS AND DESIGN HYPOTHESIS

### 3.3 SP-HX

#### Indextrut Horizontal channel support

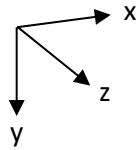

Material	Coating	Valid for
Steel	Zinc-plated	Indextrut slotted channel

#### Installation Data

Code	A1	A2	B1	B2	C	ØD	Ød	E	G1	G2	L1	L2	L3
SPGH3840	42	35	4	6	60	13,5	11	12	25	16	90	103	145

#### Drawing

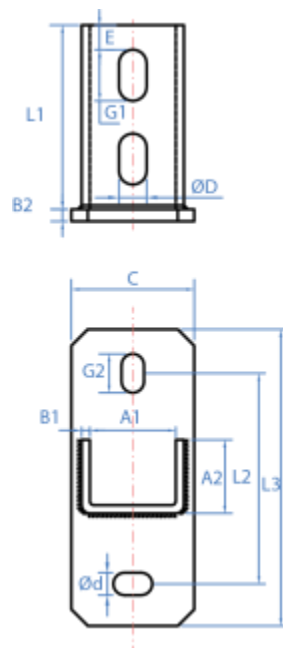

Código	Carga máxima recomendada eje X [kg]	Carga máxima recomendada eje Y [kg]	Carga máxima recomendada eje Z [kg]
SPGH3840	430	95	40

### 3.4 PR-X

#### Indextrut adjustable support

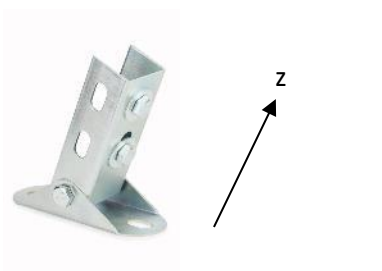

Material	Coating	Valid for
<b>A</b>	<b>Z</b> ZINC	
Steel	Zinc-plated	Indextrut slotted channel

#### Installation Data

Code	A	B	SW
PRX01	56	152,5	17

#### Drawing

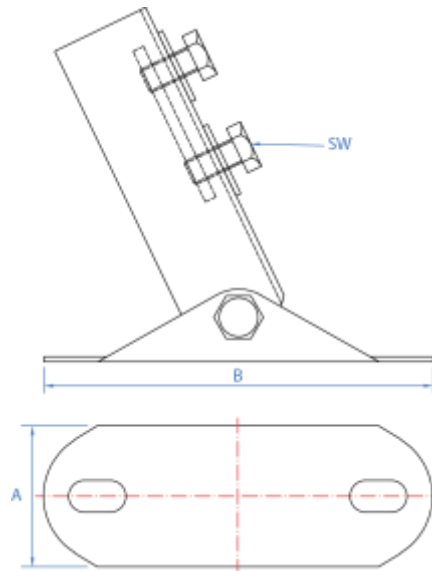

Code	Maximum recommended load Z axis [kg]
PRX01	50

### 3.5 SP-RX

#### Rectangular U base support Indextrut



Material	Coating	Valid for
<b>A</b>	<b>Z</b> ZINC	
Steel	Zinc-plated	Indextrut slotted channel

#### Installation Data

Code	L1	A	B	C	ØD	E	F	G	H
SPRXH4121	150	70	5	90	14	48	21	22,5	105
SPRXV4121	70	150	5	90	14	48	21	22,5	105

#### Drawing

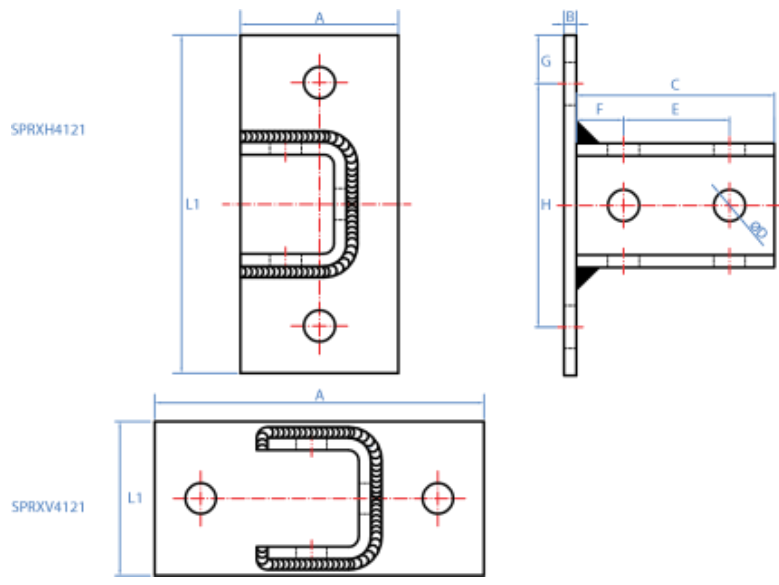

Code	Maximum recommended load Z axis [kg]
SPRXH4121	600
SPRXV4121	

### 3.6 SP-UX

#### Support U base Indextrut



Material	Coating	Valid for
Steel	Zinc-plated	Indextrut slotted channel

#### Installation Data

Code	A	B	C	ØD	E	F	G	H
SPUX412100	150	5	90	14	48	21	22,5	105
SPUX412145	150	5	90	14	48	21	22,5	105

#### Drawing

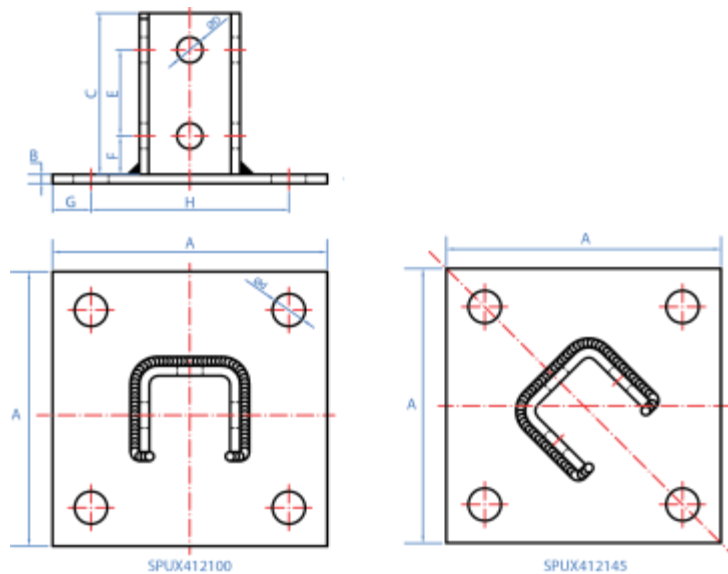

Code	Maximum recommended load Z axis [kg]
SPUX412100	600
SPUX412145	

## 4. GEOMETRIC DATA

REFERENCIA	SECTION	WEIGHT	AREA	MOMENT OF INERTIA (I <sub>y</sub> )	MOMENT OF INERTIA (I <sub>z</sub> )	RESISTANT MODULE (W <sub>y</sub> )	RESISTANT MODULE (W <sub>z</sub> )
	[mm x mm]	[Kg/m]	[cm <sup>2</sup> ]	[cm <sup>4</sup> ]	[cm <sup>4</sup> ]	[cm <sup>3</sup> ]	[cm <sup>3</sup> ]
GPX412115	41 x 21	1.21	1.41	0.89	3.58	0.70	1.75
GPX412120	41 x 21	1.55	1.99	0.95	4.44	0.75	2.17
GPX412125	41 x 21	1.71	2.28	1.32	5.54	1.03	2.70
GPX414115	41 X 41	1.65	2.42	4.88	5.99	2.05	2.92
GPX414120	41 x 41	2.09	2.65	5.84	7.62	2.46	3.72
GPX414125	41 x 41	2.53	3.28	7.08	9.25	2.98	4.51
GPX2M412120	41 x 21	1.55	1.99	0.95	4.44	0.75	2.17
GPX2M414120	41 x 41	2.09	2.65	5.84	7.62	2.46	3.72
SPX412115	41 x 21	1,88	2.28	1.32	5.54	1.03	2.70
SPX412130	41 x 21	1,88	2.28	1.32	5.54	1.03	2.70
SPX412145	41 x 21	1,88	2.28	1.32	5.54	1.03	2.70
SPX414115	41 x 41	2,70	3.28	7.08	9.25	2.98	4.51
SPX414130	41 x 41	2,70	3.28	7.08	9.25	2.98	4.51
SPX414145	41 x 41	2,70	3.28	7.08	9.25	2.98	4.51
SPX414160	41 x 41	2,70	3.28	7.08	9.25	2.98	4.51
SPX414175	41 x 41	2,70	3.28	7.08	9.25	2.98	4.51
SPX414110	41 x 41	2,70	3.28	7.08	9.25	2.98	4.51

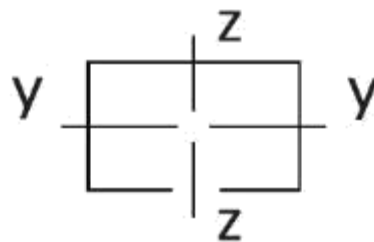

## 5. LOAD AND DESIGN HIPOTESIS

### LOAD AND DESIGN HIPOTESIS FOR SLOTTED CHANNELS GP-X

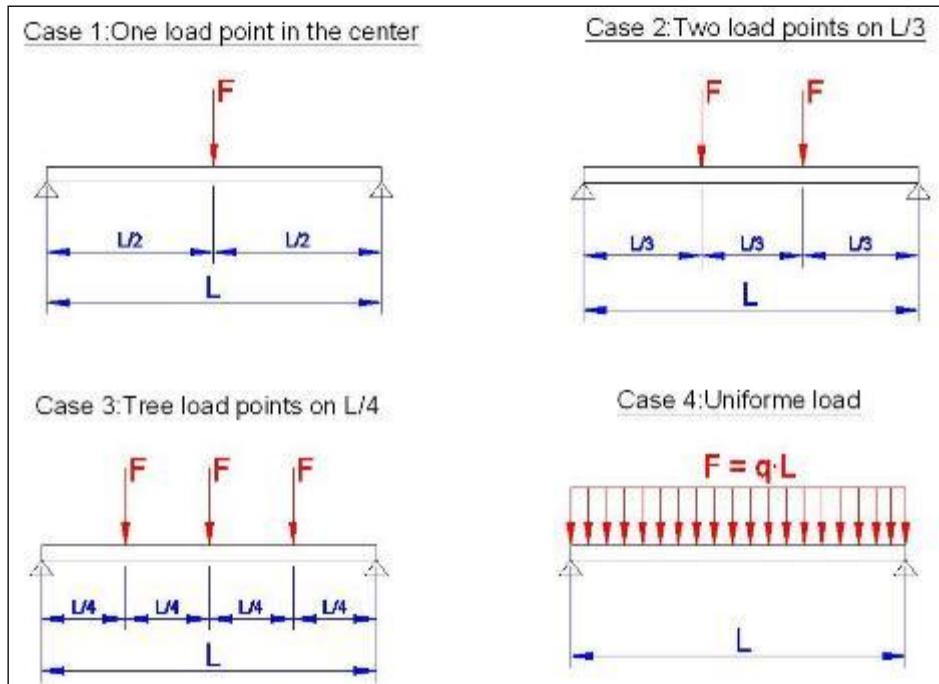

### LOAD AND DESIGN HIPOTESIS FOR CANTILEVERS SP-X

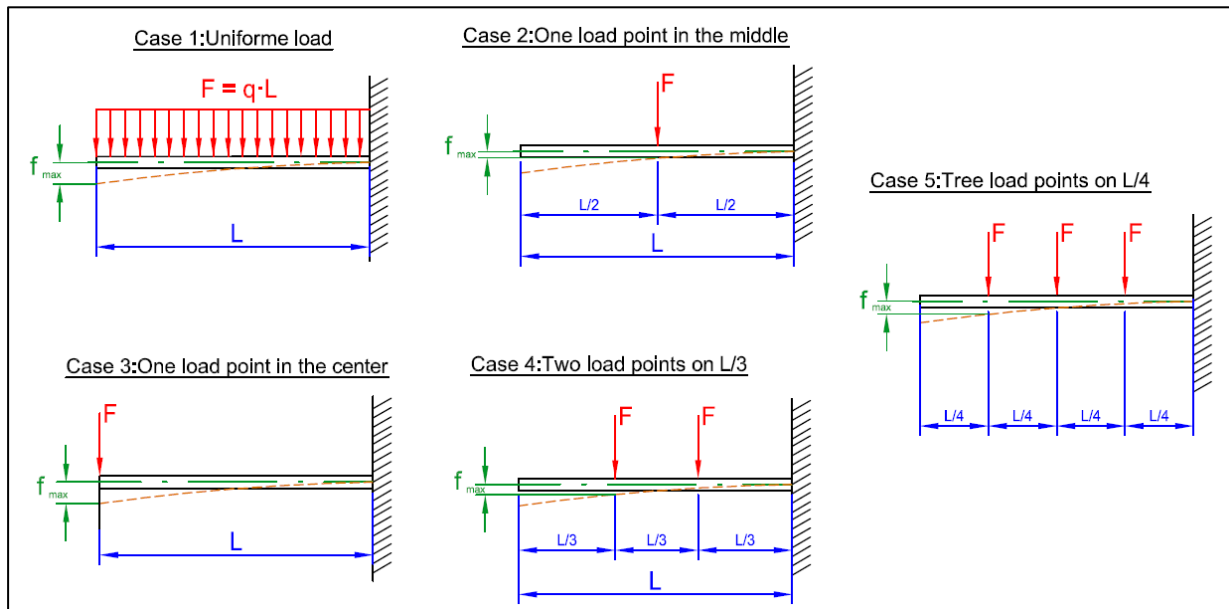

MAXIMUM RECOMMENDED LOADS FOR SLOTTED CHANNELS GP-X

Channel 412115

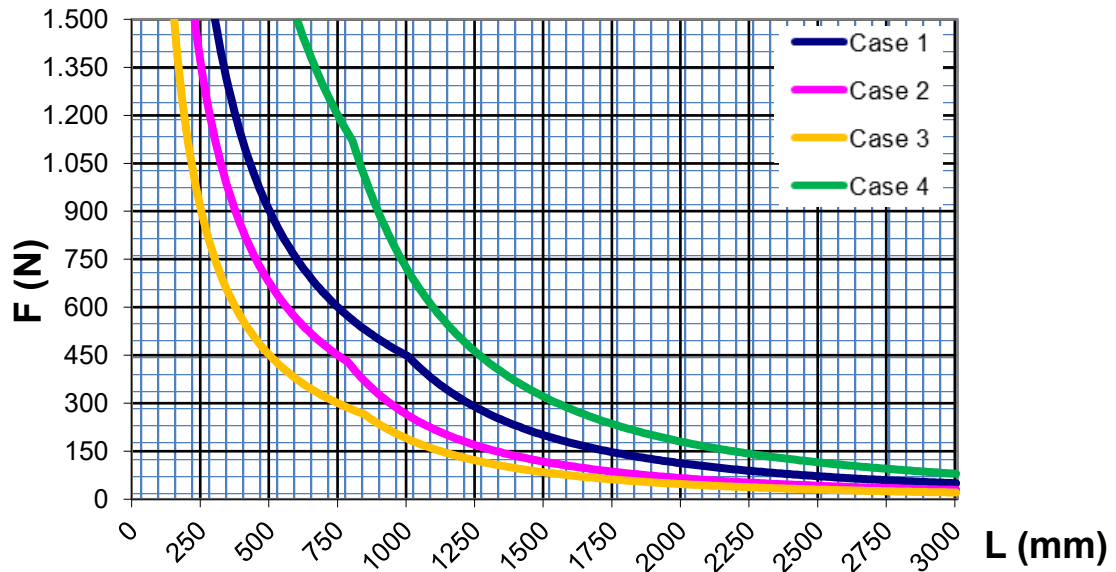

Channel 412120

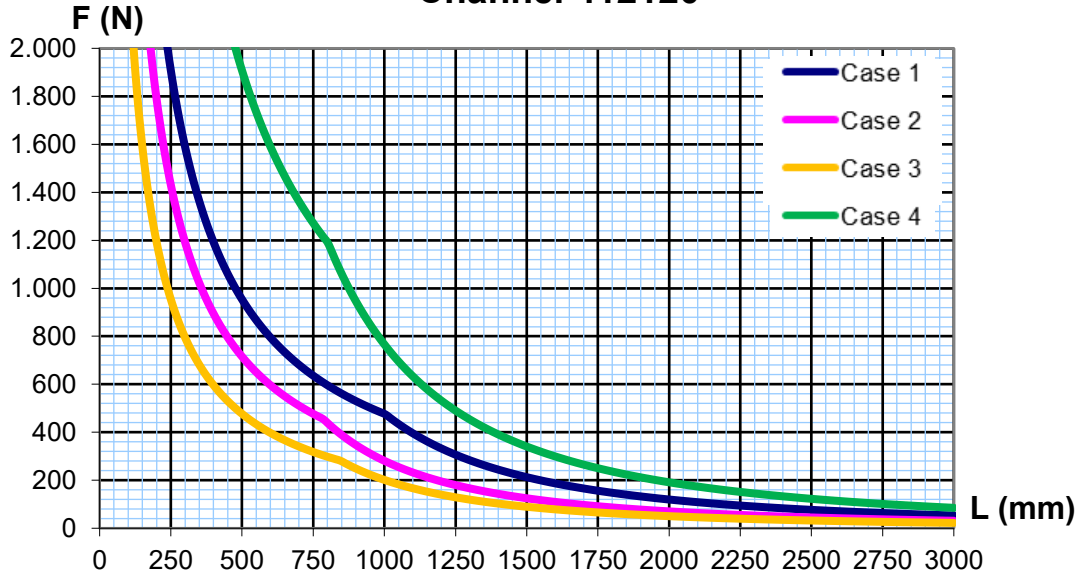

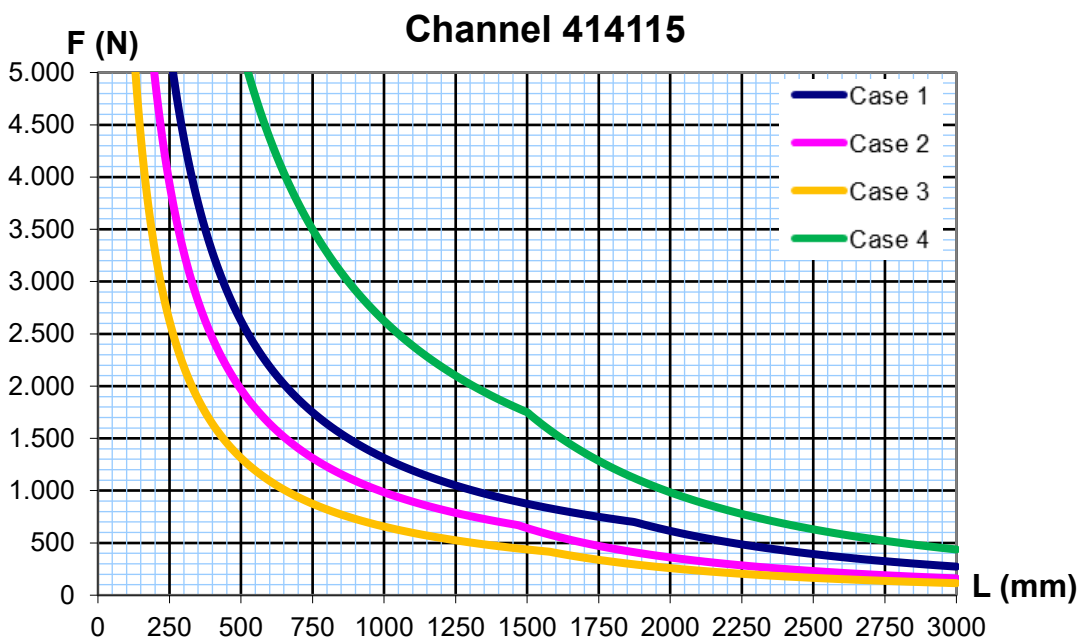
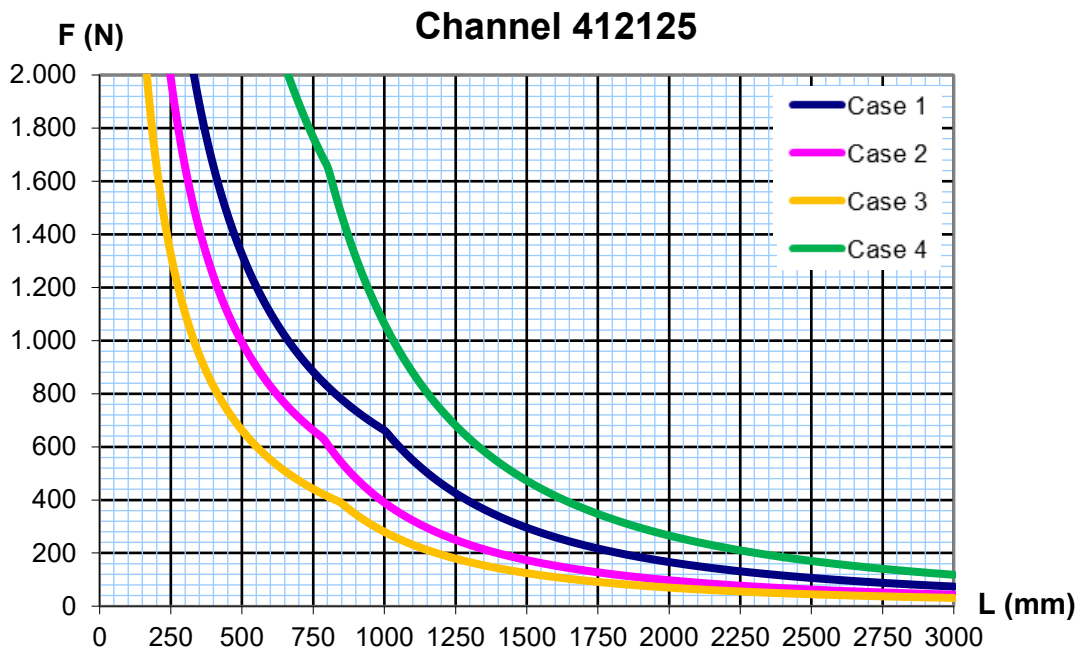

9

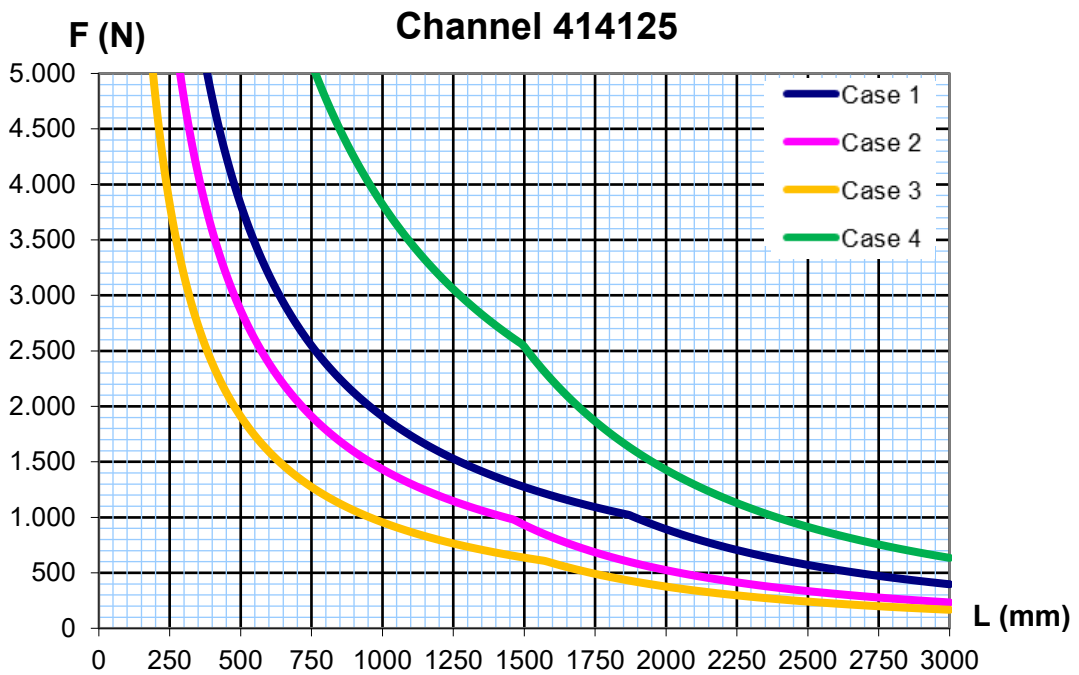
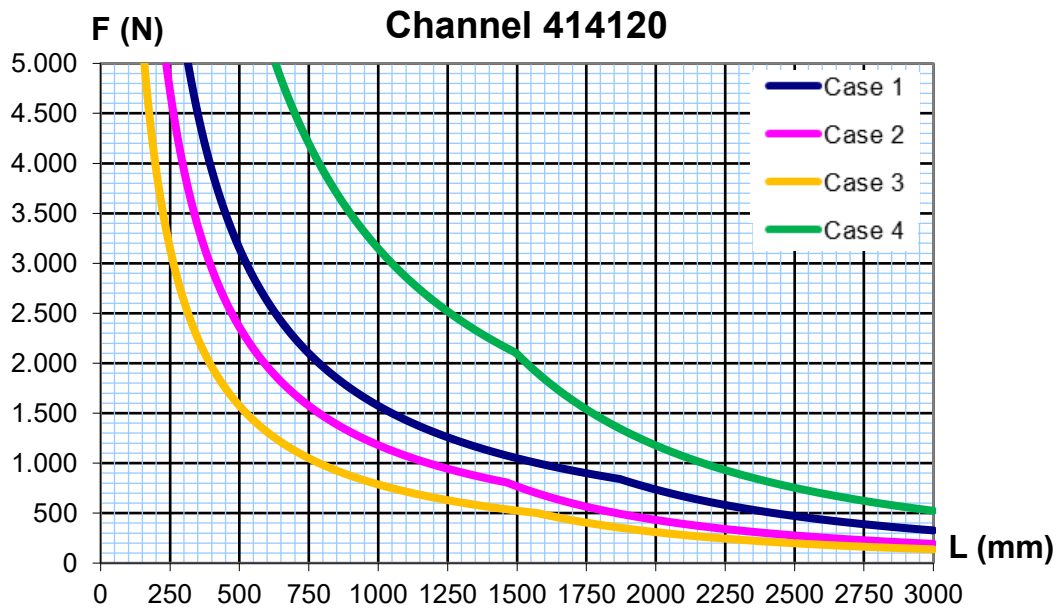

MAXIMUM RECOMMENDED LOADS FOR CANTILEVERS SP-X

Cantilever 41/21

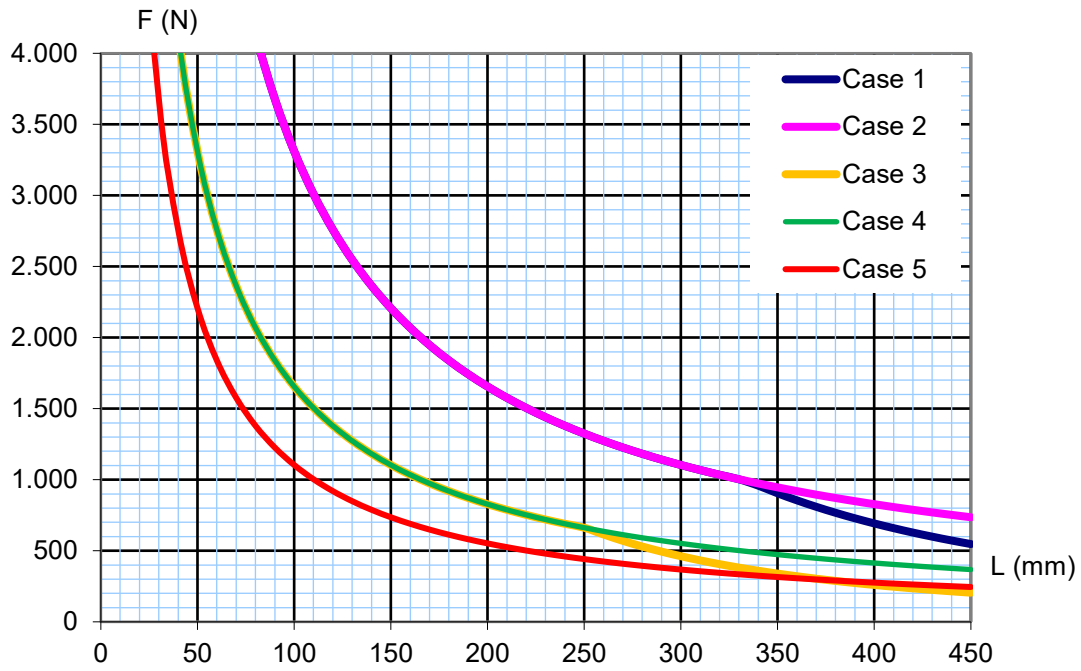

Cantilever 41/41

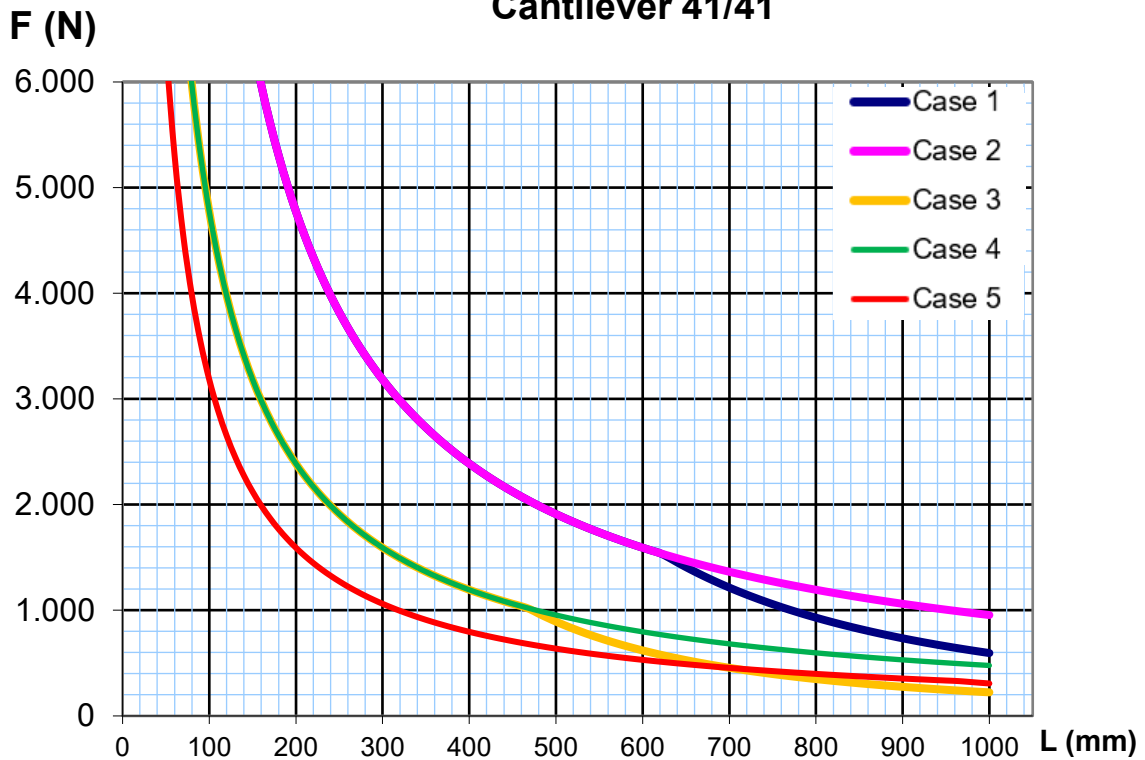

SLOTTED CHANNEL DESIGN EXAMPLE

Slotted channel design example:

Channel GPX414125: Channel Length 800 mm with three clamps equally spaced at 200 mm (case 3)

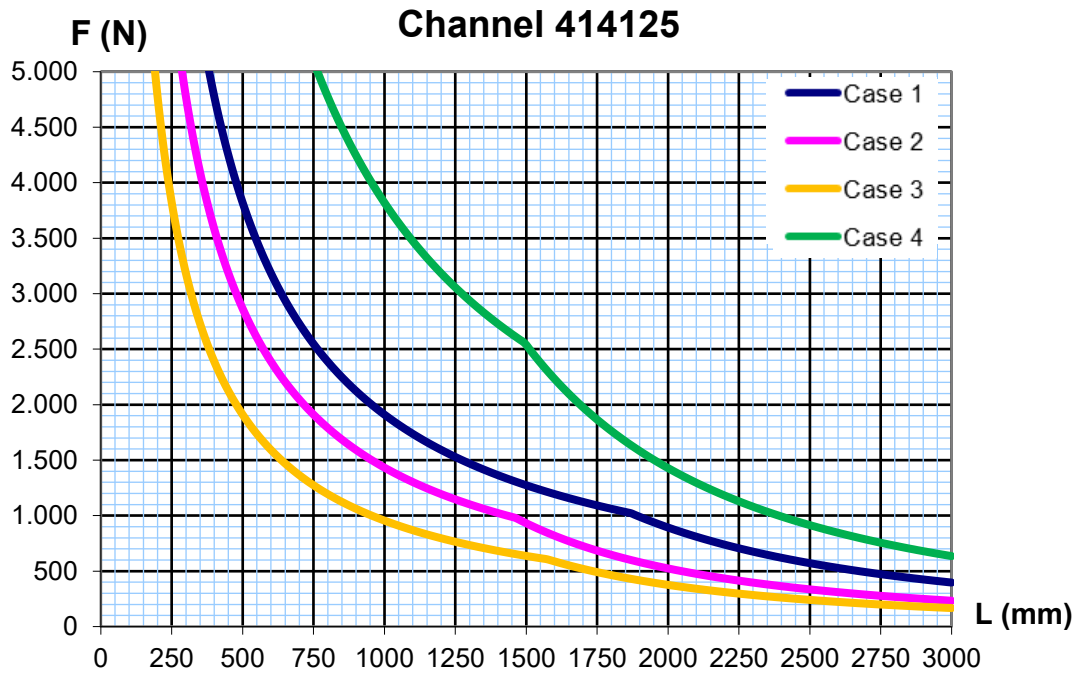
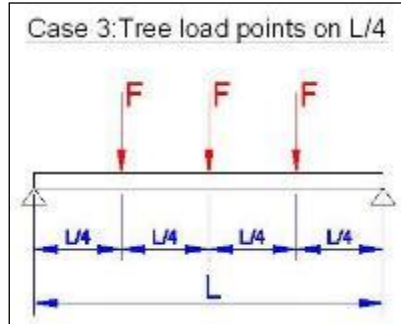

Result is an admissible load per clamp of 1.200 N ( $\approx 120$  Kg).

CANTILEVER DESIGN EXAMPLE

**Cantilever design example:**

Cantilever SPX414130: One pipe situated 150 mm from the wall (case 2).

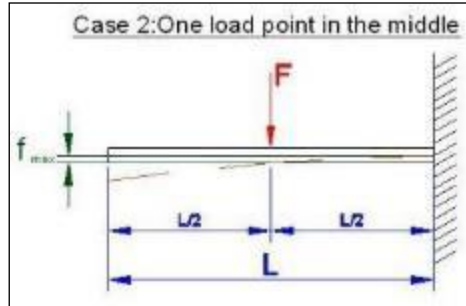

Cantilever 41/41

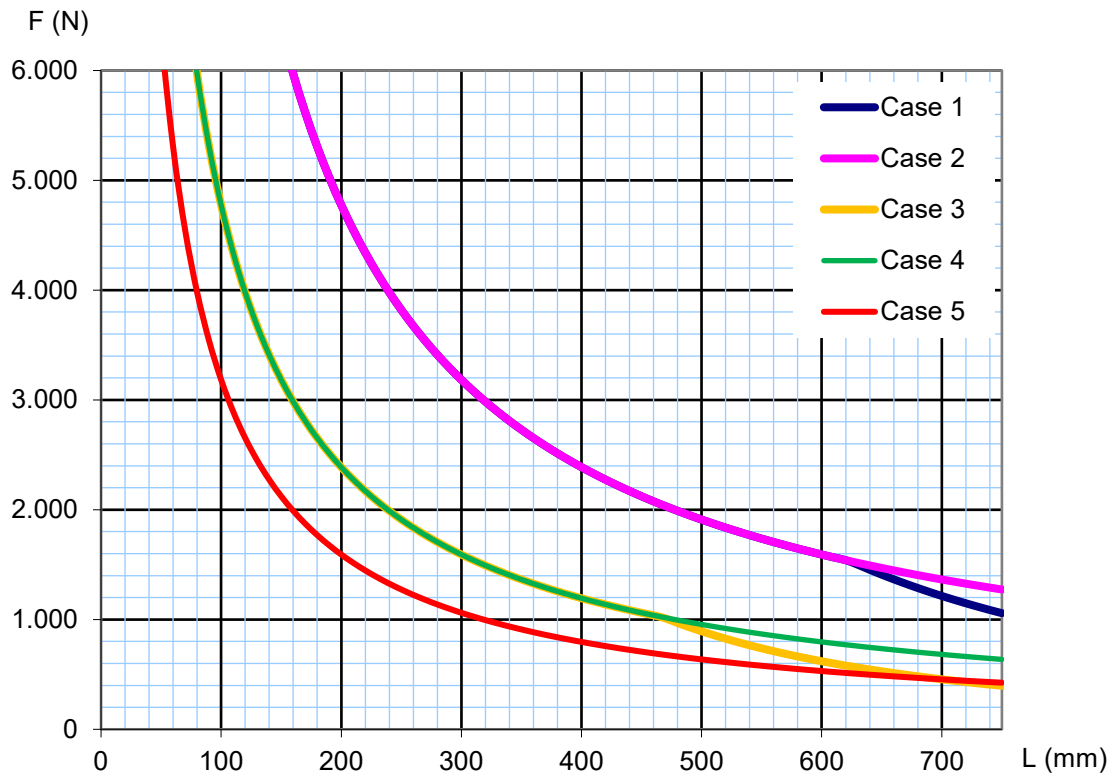

Result is an admissible load of 3.180N ( $\approx$ 318 Kg).

These admissible loads are only applicable if the cantilever is fixed with anchors complying with their guidelines of use and their corresponding applications.

Loads transmitted to the base material must be checked separately (steel and concrete)

Recommended anchors: AH08075, AH10090, MIA408075, MIA410090, HEHOM08 y HEHOM10