



AB-SF



AB-BU



AB-GP





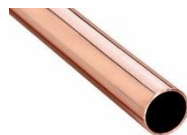

CARACTERISTIQUES

- Colliers lourdes pour les tuyaux lourds.
- Variété de formats: isophonique ou standard.
- Revêtements appropriés pour chaque situation, galvanisés, zingué, plastifiés jaune.
- Étrier avec support, flexibilité dans l'installation.
- Colliers à double filetage M8 + M10.
- Emploi: sanitaire, électrique, ventilation, climatisation, tuyaux de gaz, tuyaux d'incendie, etc.

MATÉRIAUX BASE



1. GAMME

| ITEM | CODE | PHOTO | DIMENSIONS | REVÊTEMENT | ÉPAISSEUR [mm] | LARGEUR [mm] | APPLICATIONS |
|------|-------|---|------------|---|----------------|--------------|-------------------------|
| 1 | AB-SF |  | Ø8 ÷ Ø150 |  | 0,7 – 0,8 | 9 | Sanitaire Industriel |
| 2 | AB-BU |  | Ø13 ÷ Ø21 |  | 0,5 – 0,7 | 8,7 – 9,3 | Industriel Sanitaire |
| 3 | AB-GP |  | Ø25 – Ø174 |  | 0,6 – 1,7 | 18 – 25 | Bombonne butane |

2. DONNÉES D'INSTALLATION

2.1 AB-SF

Collier sansfin



Recouvrement



Zingué

Principales utilisations



Tube flexible



Tube plastique

Données



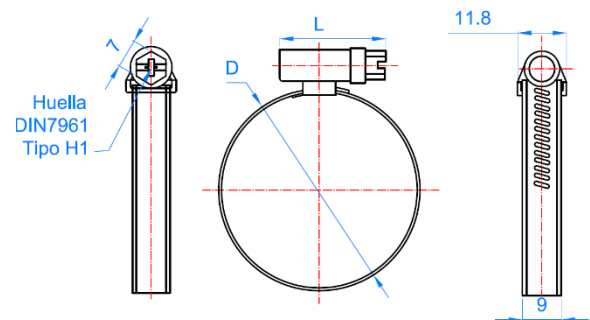

| Code | ØD (mm) | ØD (") | A x B (mm) | L | Couple de serrage (Nm) | Caractéristiques |
|-----------|-----------|----------------|------------|----|------------------------|---|
| ASF008016 | 8 ÷ 16 | 5/16 ÷ 5/8 | 9 x 0,70 | 23 | 4,50 | <ul style="list-style-type: none"> • Pour tuyaux de Ø8 jusqu'à Ø150 mm. • Finition superficielle: zingué électrolytique, recouvrement >5 microns. • Vis avec rondelle estampée, pour simplifier le serrage de la vis. • Profil en acier de 0.7 à 0.8 mm d'épaisseur, selon les dimensions. • Spécialement indiqué pour tuyaux d'arrosage, tuyaux en plastique, utilisations industrielles, etc. • Installation facile et rapide. |
| ASF12022 | 12 ÷ 22 | 1/2 ÷ 7/8 | 9 x 0,70 | 23 | 4,50 | |
| ASF16027 | 16 ÷ 27 | 5/8 ÷ 1 1/16 | 9 x 0,70 | 26 | 4,50 | |
| ASF20032 | 20 ÷ 32 | 3/4 ÷ 1 1/4 | 9 x 0,70 | 26 | 4,50 | |
| ASF25040 | 25 ÷ 40 | 1 ÷ 1 5/8 | 9 x 0,70 | 26 | 4,50 | |
| ASF30045 | 30 ÷ 45 | 1 3/16 ÷ 1 3/4 | 9 x 0,80 | 26 | 4,50 | |
| ASF35050 | 35 ÷ 50 | 1 3/8 ÷ 2 | 9 x 0,80 | 26 | 4,50 | |
| ASF40060 | 40 ÷ 60 | 1 5/8 ÷ 2 3/8 | 9 x 0,80 | 26 | 4,50 | |
| ASF50070 | 50 ÷ 70 | 2 ÷ 2 3/4 | 9 x 0,80 | 26 | 4,50 | |
| ASF60080 | 60 ÷ 80 | 2 3/8 ÷ 3 1/8 | 9 x 0,80 | 26 | 4,50 | |
| ASF70090 | 70 ÷ 90 | 2 3/4 ÷ 3 1/2 | 9 x 0,80 | 26 | 4,50 | |
| ASF80100 | 80 ÷ 100 | 3 1/8 ÷ 4 | 9 x 0,80 | 26 | 4,50 | |
| ASF90110 | 90 ÷ 110 | 3 1/2 ÷ 4 3/8 | 9 x 0,80 | 26 | 4,50 | |
| ASF100120 | 100 ÷ 120 | 4 ÷ 4 3/4 | 9 x 0,80 | 26 | 4,50 | |
| ASF110130 | 110 ÷ 130 | 4 3/8 ÷ 5 1/8 | 9 x 0,80 | 26 | 4,50 | |
| ASF120140 | 120 ÷ 140 | 4 3/4 ÷ 5 1/2 | 9 x 0,80 | 26 | 4,50 | |
| ASF130150 | 130 ÷ 150 | 5 1/8 ÷ 5 7/8 | 9 x 0,80 | 26 | 4,50 | |

PLAN



EXEMPLES D'APPLICATION

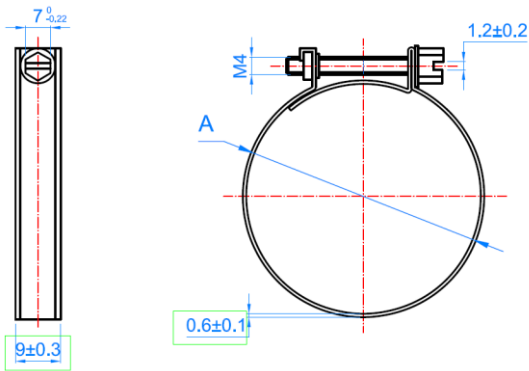

| 2.2 AB-BU | | Collier Butane | | |
|--|---------|---|---|--|
|  | | Recouvrement | | Principales utilisations |
| | |  | |  |
| | | Zingué | | Tube butane |
| Données | | | | |
| Code | ØD (mm) | A x B (mm) | Couple de serrage (Nm) | Caractéristiques |
| ABBU1315 | 13 ÷ 15 | 9 x 0,6 | 2 | <ul style="list-style-type: none"> • Pour tuyaux de Ø13 jusqu'à Ø21 mm. • Finition superficielle: zingué électrolytique, recouvrement >5 microns. • Vis avec rondelle estampée, pour simplifier le serrage de la vis. • Profil en acier de 0.6 d'épaisseur, selon les dimensions. • Spécialement indiqué pour tuyaux d'arrosage, tuyaux en plastique, utilisations industrielles, etc. • Installation facile et rapide. |
| ABBU1618 | 16 ÷ 18 | 9 x 0,6 | 2 | |
| ABBU1921 | 19 ÷ 21 | 9 x 0,6 | 2 | |
| PLAN | | | EXEMPLES D'APPLICATION | |
|  | | |  | |

2.3 AB-GP

Collier grande pression



Avantages



Revêtement



Zingué

Matériau de base

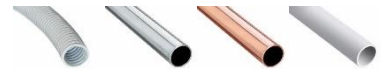

Tube Ventilation

Tube acier

Tube cuivre

Tube plastique

Données d'installation

| Code | MxL | Ø D (mm) | A | B | Caractéristiques |
|-----------|-----------|----------|----|-----|---|
| AGP023025 | M5 x 40 | 23-25 | 18 | 0,6 | <ul style="list-style-type: none"> • Pour les tuyaux de Ø23 à Ø174 mm. • Terminaison superficielle: zingué électrolytique, recouvrement >5 microns. • Vis qualité 8.8. • Profil de bande de 0.6 à 1.7 suivant la dimension. • Spécialement indiqué pour les tuyaux d'arrosage et tuyaux. • Facilité et rapidité d'installation. • Bande arrondie pour ne pas endommager le tube. • Grande capacité de serrage. |
| AGP026028 | M5 x 40 | 26-28 | 18 | 0,6 | |
| AGP029031 | M6 x 50 | 29-31 | 20 | 0,8 | |
| AGP032035 | M6 x 50 | 32-35 | 20 | 0,8 | |
| AGP036039 | M6 x 50 | 36-39 | 20 | 0,8 | |
| AGP040043 | M6 x 50 | 40-43 | 20 | 0,8 | |
| AGP044047 | M6 x 55 | 44-47 | 22 | 1,2 | |
| AGP048051 | M6 x 55 | 48-51 | 22 | 1,2 | |
| AGP052055 | M6 x 55 | 52-55 | 22 | 1,2 | |
| AGP056059 | M6 x 55 | 56-59 | 22 | 1,2 | |
| AGP060063 | M6 x 55 | 60-63 | 22 | 1,2 | |
| AGP064067 | M8 x 70 | 64-67 | 22 | 1,5 | |
| AGP068073 | M8 x 70 | 68-73 | 24 | 1,5 | |
| AGP074079 | M8 x 70 | 74-79 | 24 | 1,5 | |
| AGP080085 | M8 x 70 | 80-85 | 24 | 1,5 | |
| AGP086091 | M8 x 70 | 86-91 | 24 | 1,5 | |
| AGP092097 | M8 x 70 | 92-97 | 24 | 1,5 | |
| AGP098103 | M8 x 70 | 98-103 | 24 | 1,5 | |
| AGP104112 | M8 x 80 | 104-112 | 24 | 1,5 | |
| AGP113121 | M8 x 80 | 113-121 | 24 | 1,5 | |
| AGP122130 | M8 x 80 | 122-130 | 24 | 1,5 | |
| AGP131139 | M10 x 90 | 131-139 | 25 | 1,5 | |
| AGP140148 | M10 x 90 | 140-148 | 25 | 1,5 | |
| AGP149161 | M10 x 110 | 149-161 | 25 | 1,7 | |
| AGP162174 | M10 x 110 | 162-174 | 25 | 1,7 | |

PLAN

