

## MO-V

## CHARACTERISTICS

## CERTIFICATES



- Assessed for all types of concrete, non-cracked, and all concrete applications.
- Assessed studs from M8 to M24.
- Use for high loads.
- Valid for dry, wet and flooded holes.
- Use for static or quasi-static loads.
- Versions in zinc plated steel and stainless steel A2 and A4.
- Temperature range: from -40°C to +80°C (long term maximum temperature +50°C).



## APPLICATIONS

- Use in indoor and outdoor environments.
- Structural applications.
- Fixing roadside fencing.
- Fixing notices, machinery, boilers, signs, billboards, etc.



## BASE MATERIAL



## MAXIMUM LOAD RECOMMENDED [kg]

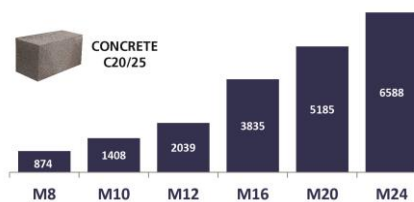

## DRILL HOLE CONDITION

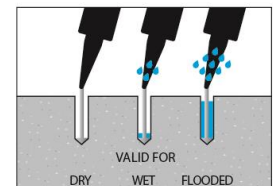

## APPLICATION EXAMPLES



## VALID FOR

STUD





M8-M24 Stud

## 1. RANGE



ITEM	CODE	SIZE	PHOTO	COMOPONENT	MATERIAL	
1	<b>MOV300</b> <b>MOV410</b>	300 ml. 410 ml.		VNINYLESTER MORTAR	Vinylester resin Format: cartridges of 300 and 410 ml	12

## 2. ACCESSORIES

ITEM	CODE	PHOTO	COMPONENT	MATERIAL
1	<b>MOPISSI</b>		APPLICATION GUNS	Gun for 300 ml standard cartridges
	<b>MOPISTO</b>			Gun for 410 ml coaxial cartridges
2	<b>EQ-AC</b> <b>EQ-8.8</b> <b>EQ-A2</b> <b>EQ-A4</b>		STUD BOLTS	Threaded steel stud, class 5.8 ISO 898-1 Threaded steel stud, class 8.8 ISO 898-1 Threaded stainless steel stud A2-70 Threaded stainless steel stud A4-70
3	<b>MORCEPKIT</b>		CLEANING BRUSHES	3 Cleaning brushes kit of $\varnothing 14$ , $\varnothing 20$ and $\varnothing 29$ mm.
4	<b>MOBOMBA</b>		CLEANING PUMP	Pump for cleaning dust and drill hole fragments
5	<b>MORCANU</b>		MIXING NOZZLE	Plastic. Helix static mixer.
6	<b>MO-TN</b>		NYLON SLEEVE	Plastic. Available in white and grey
7	<b>MO-TR</b>		METAL THREADED SLEEVE	Metal threaded sleeve M8, M10, M12, zinc plated.
8	<b>MO-TM</b>		METAL SLEEVE	Metal sleeve of $\varnothing 12$ , $\varnothing 16$ and $\varnothing 22$ ,

## 3. INSTALLATION DATA

### 3.1. CONCRETE FIXING (SET UP PARAMETERS)

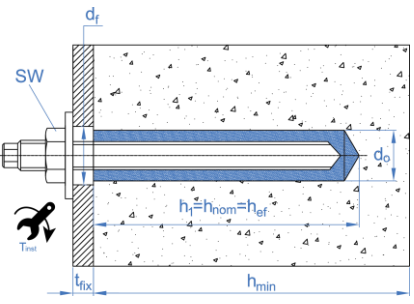
SIZE		M8	M10	M12	M16	M20	M24
$d_0$ : nominal diameter	[mm]	10	12	14	18	22	26
$d_f$ : fixture hole diameter $\leq$	[mm]	9	12	14	18	22	26
$T_{ins}$ : torque $\leq$	[Nm]	10	20	40	80	150	200
Circular cleaning brush diameter		$\varnothing 14$		$\varnothing 20$		$\varnothing 29$	
<b><math>h_{ef,min} = 8d</math></b>							
$h_1$ : drill hole depth	[mm]	64	80	96	128	160	192
$s_{cr,N}$ : critical spacing	[mm]	192	240	288	384	480	576
$c_{cr,N}$ : critical edge distance	[mm]	96	120	144	192	240	288
$c_{min}$ : minimum distance to edge	[mm]	35	40	50	65	80	96
$s_{min}$ : minimum spacing	[mm]	35	40	50	65	80	96
$h_{min}$ : minimum concrete thickness	[mm]	100	110	126	158	204	244
<b>Standard Stud</b>							
$h_1$ : drill hole depth	[mm]	80	90	110	128	170	210
$s_{cr,N}$ : critical spacing	[mm]	240	270	330	384	510	630
$c_{cr,N}$ : critical edge distance	[mm]	120	135	165	192	255	315
$c_{min}$ : minimum distance to edge	[mm]	43	45	56	65	85	105
$s_{min}$ : minimum spacing	[mm]	43	45	56	65	85	105
$h_{min}$ : minimum concrete thickness	[mm]	110	120	140	158	214	262
<b><math>h_{ef,max} = 12d</math></b>							
$h_1$ : drill hole depth	[mm]	96	120	144	192	240	288
$s_{cr,N}$ : critical spacing	[mm]	288	360	432	576	720	864
$c_{cr,N}$ : critical edge distance	[mm]	144	180	216	288	360	432
$c_{min}$ : minimum distance to edge	[mm]	50	60	70	95	120	145
$s_{min}$ : minimum spacing	[mm]	50	60	70	95	120	145
$h_{min}$ : minimum concrete thickness	[mm]	126	150	174	222	284	340
5.8 / 8.8 Zinc plated stud code 		EQAC08110 EQ8808110	EQAC10130 EQ8810130	EQAC12160 EQ8812160	EQAC16190 EQ8816190	EQAC20260 EQ8820260	EQAC24300 EQ8824300
A2 / A4 Stainless steel stud code 		EQA208110 EQA408110	EQA210130 EQA410130	EQA212160 EQA412160	EQA216190 EQA416190	EQA220260 EQA420260	EQA224300 EQA424300
		<ul style="list-style-type: none"> <li><math>h_{ef}</math> depth value may be selected by the user ranging between <math>h_{ef,min} = 8d</math> and <math>h_{ef,max} = 12d</math>. Any intermediate values may be interpolated.</li> <li>Critical distances are those where anchors in a group of anchors are not influenced by one another with regard to tension load effects. For smaller distances, down to minimum distances, corresponding reduction coefficients must be applied.</li> <li>Standard studs are available for each measurement, as shown in the table.</li> </ul>					

## 4. PRODUCT SET UP

### 4.1. CONCRETE SET UP

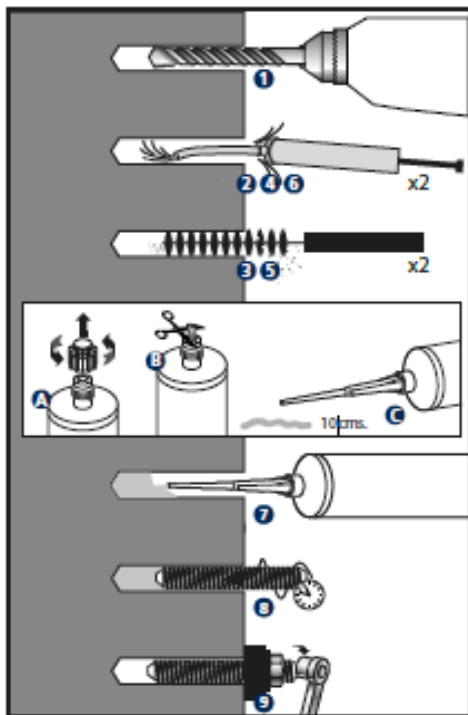

#### 1. DRILL

Check the concrete base is compact and porosity is insignificant.  
 Suitable for wet, dry or flooded drill holes.  
 Cartridge installation temperature:  $\geq 5\text{ }^{\circ}\text{C}$ .  
 Base material installation temperature: MO-V  $\geq +5\text{ }^{\circ}\text{C}$   
 Use drill in hammer mode.  
 Drill to the specified diameter and depth values

#### 2 - 6. BLOW AND CLEAN

Clear the drill holes completely of dust and fragments by following the procedure shown in the picture. If the drill hole is flooded, the water must be removed before mortar is injected.

#### A – B\* – C. OPEN CARTRIDGE

Screw the nozzle into the cartridge and place the assembly in the application gun. Squeeze on the trigger repeatedly until the mortar comes out of the nozzle in a uniform grey color. Any iridescence indicates improper mixing. Always discard the first two doses of each cartridge: these are never to be used for fixing. \*For 300 ml cartridges, cut end of bag, behind seal clip.

#### 7. INJECT MORTAR

Insert the nozzle to the bottom of the drill hole and apply mortar: gradually remove the nozzle, ensuring there are no air bubbles. Fill the hole to  $\frac{1}{2}$  and  $\frac{3}{4}$  of its depth.  
 In the event of not fully using the cartridge, leave nozzle attached. Only change if using again and handling time has expired, remembering to discard the first two doses of mortar.

#### 8. INSTALLATION

Introduce the stud to be installed by screwing it lightly down to the installation depth value manually; ensuring the mortar covers the stud thread. The introduction of the anchor must take place within the handling time. The mortar must seep from the top of the drill hole to ensure it is completely full and there are no gaps between the stud and the drill hole.

### TEMPERATURE AND CURING TIME

TYPE	Base material temperature [ $^{\circ}\text{C}$ ]	Handling time [min]	Curing time [min]
MO-V	min +5	18	120
	+5 to +10	12	120
	+10 to +20	6	80
	+20 to +25	4	40
	+25 to +30	3	30
	+30 to +35	2	20
	+35 to +40	1.5	15
	+40	1.5	10

#### 9. APPLY TORQUE

Once the curing time has elapsed, apply torque, never exceeding the values indicated in the table.

## 5. STORAGE CONDITIONS

Keep the product stored in a cool, dry place, away from direct sunlight and heat sources, at an average temperature between +5 °C and +25 °C.



Shelf life of unopened cartridge: 18 months from the date of manufacture. The expiration date is indicated on the cartridge.

## 6. RESISTANCES

### 6.1 CONCRETE FIXATION

Characteristic resistances for C20/25 concrete for an isolated anchor (without considering anchor-to-anchor or anchor-to-edge distance effects) and class 5.8 studs or A4-70 stainless steel are shown in tables below.

#### CHARACTERISTIC RESISTANCES

CONCRETE CLASS	SIZE				M8	M10	M12	M16	M20	M24	
NON-CRACKED CONCRETE	ZINC PLATED	Tension	$h_{ef,min} = 8d$	$N_{Rk}$	[kN]	19,3	25,1	43,4	64,3	85,4	108,5
			Standard stud 5.8	$N_{Rk}$	[kN]	<u>18,0</u>	28,2	49,7	64,3	90,7	118,7
			Standard stud 8.8	$N_{Rk}$	[kN]	24,1	28,2	49,7	64,3	90,7	118,7
			$h_{ef,max} = 12d - 5.8$	$N_{Rk}$	[kN]	<u>18,0</u>	<u>29,0</u>	<u>42,0</u>	<u>79,0</u>	128,1	162,8
		$h_{ef,max} = 12d - 8.8$	$N_{Rk}$	[kN]	28,9	37,7	65,1	96,5	128,1	162,8	
		Shear	All depths 5.8	$V_{Rk}$	[kN]	<u>9,0</u>	<u>15,0</u>	<u>21,0</u>	<u>39,0</u>	<u>61,0</u>	<u>88,0</u>
	All depths 8.8		$V_{Rk}$	[kN]	<u>15,0</u>	<u>23,0</u>	<u>34,0</u>	<u>63,0</u>	<u>98,0</u>	<u>141,0</u>	
	STAINLESS STEEL	Tension	$h_{ef,min} = 8d$	$N_{Rk}$	[kN]	19,3	25,1	43,4	64,3	85,4	108,5
			Standard stud	$N_{Rk}$	[kN]	24,1	28,2	49,7	64,3	90,7	118,7
			$h_{ef,max} = 12d$	$N_{Rk}$	[kN]	<u>26,0</u>	37,7	<u>59,0</u>	96,5	128,1	162,8
		Shear	All depths	$V_{Rk}$	[kN]	<u>13,0</u>	<u>20,0</u>	<u>30,0</u>	<u>55,0</u>	<u>86,0</u>	<u>124,0</u>

**DESIGN RESISTANCES**

CONCRETE CLASS	SIZE				M8	M10	M12	M16	M20	M24	
	NON-CRACKED CONCRETE	ZINC PLATED	Tension	$h_{ef,min} = 8d$	$N_{Rd}$	[kN]	10,7	13,9	24,1	35,7	47,4
Standard stud 5.8				$N_{Rd}$	[kN]	<u>12,0</u>	15,7	27,6	35,7	50,4	65,9
Standard stud 8.8				$N_{Rd}$	[kN]	13,4	15,7	27,6	35,7	50,4	65,9
$h_{ef,max} = 12d - 5.8$			$N_{Rd}$	[kN]	<u>12,0</u>	<u>19,3</u>	<u>28,0</u>	<u>52,6</u>	71,2	90,4	
$h_{ef,max} = 12d - 8.8$			$N_{Rd}$	[kN]	16,0	20,9	36,1	53,6	71,2	90,4	
Shear			All depths 5.8	$V_{Rd}$	[kN]	<u>7,2</u>	<u>12,0</u>	<u>16,8</u>	<u>31,2</u>	<u>48,8</u>	<u>70,4</u>
		All depths 8.8	$V_{Rd}$	[kN]	<u>12,0</u>	<u>18,4</u>	<u>27,2</u>	<u>50,4</u>	<u>78,4</u>	<u>112,8</u>	
STAINLESS STEEL		Tension	$h_{ef,min} = 8d$	$N_{Rd}$	[kN]	10,7	13,9	24,1	35,7	47,4	60,3
			Standard stud	$N_{Rd}$	[kN]	13,4	15,7	27,6	35,7	50,4	65,9
			$h_{ef,max} = 12d$	$N_{Rd}$	[kN]	<u>13,6</u>	20,9	<u>31,0</u>	53,6	71,2	90,4
		Shear	All depths	$V_{Rd}$	[kN]	<u>8,3</u>	<u>12,8</u>	<u>19,2</u>	<u>35,2</u>	<u>55,1</u>	<u>79,4</u>

**MAXIMUM LOADS RECOMMENDED (when  $\gamma_F = 1.4$ )**

CONCRETE CLASS	SIZE				M8	M10	M12	M16	M20	M24	
	NON-CRACKED CONCRETE	ZINC PLATED	Tension	$h_{ef,min} = 8d$	$N_{rec}$	[kN]	7,6	9,9	17,2	25,5	33,9
Standard stud 5.8				$N_{rec}$	[kN]	<u>8,5</u>	11,2	19,7	25,5	36,0	47,1
Standard stud 8.8				$N_{rec}$	[kN]	9,5	11,2	19,7	25,5	36,0	47,1
$h_{ef,max} = 12d - 5.8$			$N_{rec}$	[kN]	<u>8,5</u>	<u>13,8</u>	<u>20,0</u>	<u>37,6</u>	50,8	64,6	
$h_{ef,max} = 12d - 8.8$			$N_{rec}$	[kN]	11,4	14,9	25,8	38,3	50,8	64,6	
Shear			All depths 5.8	$V_{rec}$	[kN]	<u>5,1</u>	<u>8,5</u>	<u>12,0</u>	<u>22,2</u>	<u>34,8</u>	<u>50,2</u>
		All depths 8.8	$V_{rec}$	[kN]	<u>8,5</u>	<u>13,1</u>	<u>19,4</u>	<u>36,0</u>	<u>56,0</u>	<u>80,5</u>	
STAINLESS STEEL		Tension	$h_{ef,min} = 8d$	$N_{rec}$	[kN]	7,6	9,9	17,2	25,5	33,9	43,0
			Standard stud	$N_{rec}$	[kN]	9,5	11,2	19,7	25,5	36,0	47,1
			$h_{ef,max} = 12d$	$N_{rec}$	[kN]	<u>9,7</u>	14,9	<u>22,1</u>	38,3	50,8	64,6
		Shear	All depths	$V_{rec}$	[kN]	<u>5,9</u>	<u>9,1</u>	<u>13,7</u>	<u>25,1</u>	<u>39,3</u>	<u>56,7</u>

1 kN ≈ 100 kg

The italic font underlined values indicate steel failure; rest indicates pull-out failure.

**COEFFICIENTS FOR TENSION LOADS**

**IN PULL-OUT FAILURE IN HIGH-RESISTANCE CONCRETE TYPES**

CONCRETE COEFFICIENT	C30/37	C40/50	C50/60
$\Psi_c$ (Non-cracked)	1,12	1,19	1,30

## 6.2 CHEMICAL RESISTANCE

Chemical resistance of the product for different kind of chemical environments and for a specific concentration.

Chemical Environment	Concentration	Result	Chemical Environment	Concentration	Result
Aqueous Solution Acetic Acid	10%	✓	Hexane	100%	C
Acetone	100%	NO DATA	Hydrochloric Acid	10%	✓
Aqueous Solution Aluminium Chloride	Saturado	✓		15%	✓
Aqueous Solution Aluminium Nitrate	10%	✓		25%	C
Ammonia Solution	5%	NO DATA	Hydrogen Sulphide Gas	100%	✓
Jet Fuel	100%	NO DATA	Isoproyl Alcohol	100%	NO DATA
Benzene	100%	NO DATA	Linseed Oil	100%	✓
Benzoic Acid	Saturado	✓	Lubricating Oil	100%	✓
Benzyl Alcohol	100%	NO DATA	Mineral Oil	100%	✓
Sodium Hypochlorite Solution	5 - 15%	✓	Paraffin / Kerosene (Domestic)	100%	C
Butyl Alcohol	100%	C	Phenol Aqueous Solution	1%	NO DATA
Calcium Sulphate Aqueous Solution	Saturado	✓	Phosphoric Acid	50%	✓
Carbon Monoxide	Gas	✓	Potassium Hydroxide	10% / pH13	C
Carbon Tetrachloride	100%	NO DATA	Sea Water	100%	C
Chlorine Water	Saturado	NO DATA	Styrene	100%	NO DATA
Chloro Benzene	100%	NO DATA	Sulphur Dioxide Solution	10%	✓
Citric Acid Aqueous Solution	Saturado	✓	Sulphur Dioxide (40°C)	5%	✓
Cyclohexanol	100%	✓	Sulphuric Acid	10%	✓
Diesel Fuel	100%	C		50%	✓
Diethylene Glycol	100%	✓	Turpentine	100%	C
Ethanol	95%	NO DATA	White Spirit	100%	✓
Ethanol Aqueous Solution	20%	C	Xylene	100%	NO DATA
Heptane	100%	C	<b>Contact only to a maximum of 25°C.</b>		C
<b>Resistant to 75°C with at least 80% of physical properties retained.</b>		✓	<b>Not Resistant</b>		X

## 7. OFFICIAL DOCUMENTATION

The following documents are available through our Sales Department or on our official website: [www.indexfix.com](http://www.indexfix.com):

- MOV Safety Data Sheet.
- European Technical Assessment ETA 13/0753 for use on non-cracked concrete according to EAD 330499-00-0601 Guide, option 7, for M8 to M24.
- Declaration of Performance DoP MOV
- INDEXcal anchor calculation software.
- INDEXmor cartridge calculation needs software.