

TPA-C



PRODUCT DESCRIPTION

- Pre-assembled aluminium closed triangle

CHARACTERISTICS

- Inclined structure for installation of roof-mounted solar panels.
- Pre-assembled product.
- Includes 3 long profiles that make up the structure, an upper section, a lower section, and a base, manufactured from EN AW 6063-T6 extruded aluminium.
- Includes two base support sections, both manufactured from EN AW 6005-T6 extruded aluminium.
- Includes 2 **DIN-6921 M8x50** bolts, 2 **DIN-6923 M8** nuts, 2 **DIN-6921 M8x18** bolts, 2 **DIN 125** plain washer and 1 **M8x30** coupling nut in A2-70 stainless steel.
- For outside use.
- Designed for **triangular aluminium systems** with **PSE-C** format continuous profiles.
- Wide range of inclination available: 5°, 10°, 15°, 20°, 25°, 30° y 35°.
- Secure folding position with incorporated fixture.
- Option of vertically mounting solar panels to a height of up to two metres.
- Central upper profile groove compatible with SW13 hexagonal socket.
- Option for triangles in sizes manufactured to order on request.

ASSESSMENTS



APPLICATIONS/MOUNTING ACCESSORIES



PSE-C



KFSFCM08

These are used in **triangular aluminium installation systems** as an inclined structural element onto which continuous **PSE-C** profiles can be mounted. Solar panels are finally attached to and supported by these profiles.

To attach **PSE-C** profiles to triangles, two **KFSFCM08** “cross connector for lateral fixing” are used.

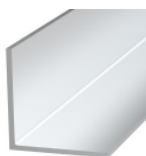

TPA-P



ABEI5519

If it is necessary to install braces between adjoining triangles, **TPA-P** “strut profiles for pre-assembled aluminium triangles” should be used. Strut profiles are diagonally attached to profile bars of the two corresponding triangles using **ABEI5519** A2-70 stainless steel self-drilling screws.

BASE MATERIAL/DIRECT MOUNTING

See technical data sheet:





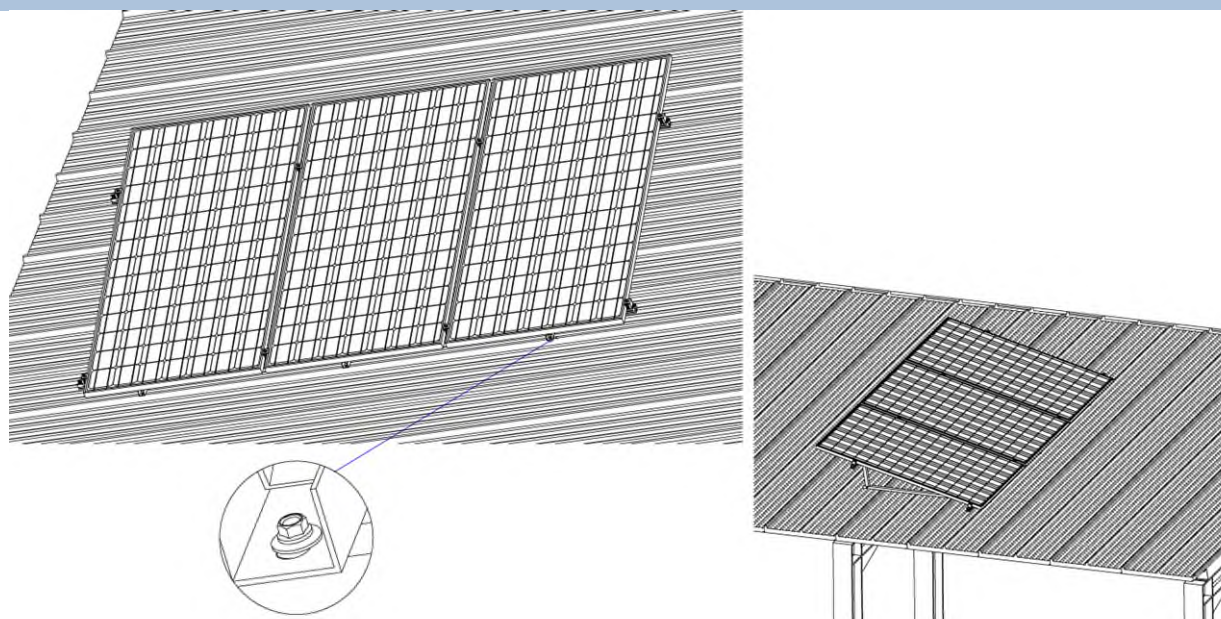















- ST-PTC: Closed triangular aluminium mounting system. Assembled fixing

APPLICATION EXAMPLES



Application example 1: Assembly on sandwich panel roof sub-structure

1. RANGE

ITEM	CODE	PHOTO	DESCRIPTION	ANGLE	LENGTH	MATERIAL
1	TPAC051230		Pre-assembled aluminium closed triangle	5°	1230 mm	 EN AW 6063-T6
						 A2-70
2	TPAC051750		Pre-assembled aluminium closed triangle	5°	1750 mm	 EN AW 6063-T6
						 A2-70
3	TPAC101230		Pre-assembled aluminium closed triangle	10°	1230 mm	 EN AW 6063-T6
						 A2-70
4	TPAC101750		Pre-assembled aluminium closed triangle	10°	1750 mm	 EN AW 6063-T6
						 A2-70
5	TPAC151230		Pre-assembled aluminium closed triangle	15°	1230 mm	 EN AW 6063-T6
						 A2-70
6	TPAC151750		Pre-assembled aluminium closed triangle	15°	1750 mm	 EN AW 6063-T6
						 A2-70
7	TPAC201230		Pre-assembled aluminium closed triangle	20°	1230 mm	 EN AW 6063-T6
						 A2-70

8	TPAC201750		Pre-assembled aluminium closed triangle	20°	1750 mm	EN AW 6063-T6
						A2-70
9	TPAC251230		Pre-assembled aluminium closed triangle	25°	1230 mm	EN AW 6063-T6
						A2-70
10	TPAC251750		Pre-assembled aluminium closed triangle	25°	1750 mm	EN AW 6063-T6
						A2-70
11	TPAC301230		Pre-assembled aluminium closed triangle	30°	1230 mm	EN AW 6063-T6
						A2-70
12	TPAC301750		Pre-assembled aluminium closed triangle	30°	1750 mm	EN AW 6063-T6
						A2-70
13	TPAC351750		Pre-assembled aluminium closed triangle	35°	1750 mm	EN AW 6063-T6
						A2-70
14	TPAC351750		Pre-assembled aluminium closed triangle	35°	1750 mm	EN AW 6063-T6
						A2-70

2. INSTALLATION INFORMATION

2.1 TPA-C

Pre-assembled aluminium closed triangle

	Materials		Compatible		Assembly accessories	
	AW 6063-T6	A2-70				
	<p>BASE MATERIAL/FIXING</p> <p>See technical data sheet:</p> <ul style="list-style-type: none"> ST-PTC: Closed triangular aluminium mounting system. Assembled fixing 					

Measurement table 1

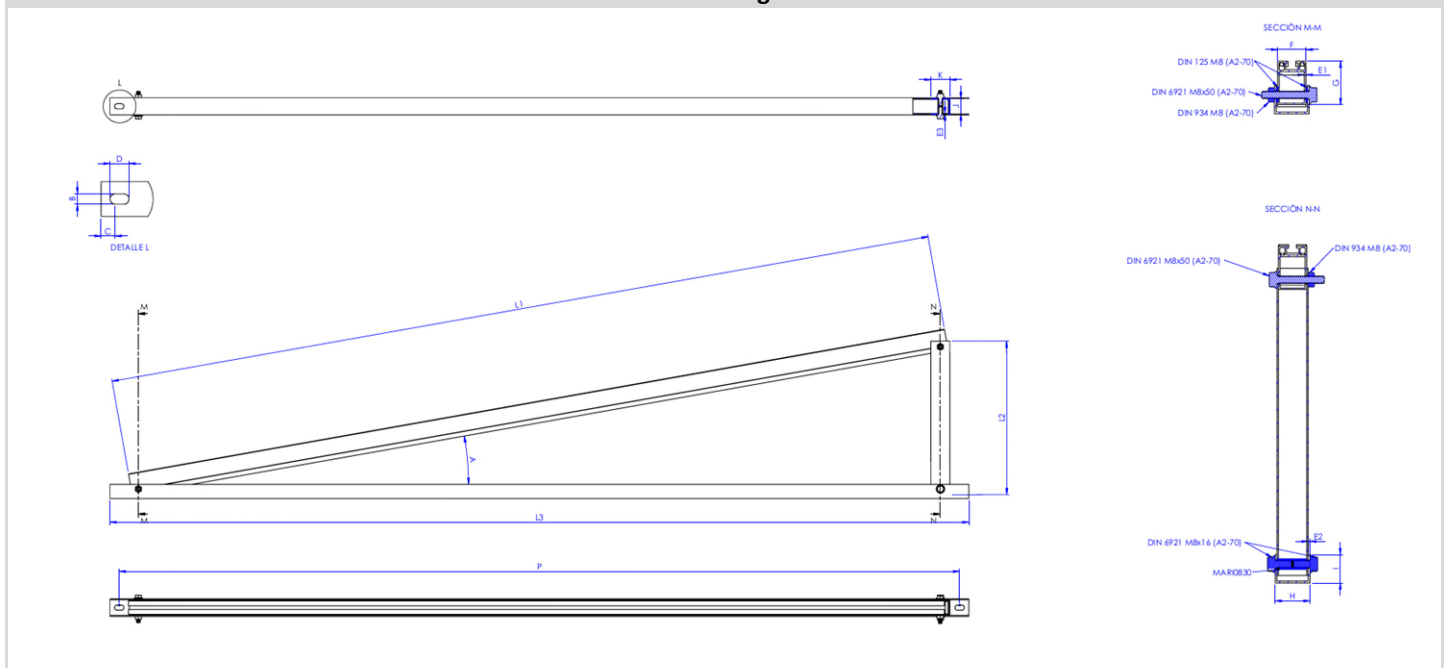

Code	A (°)	L1 (mm)	L2 (mm)	L3 (mm)	E1 (mm)	E2 (mm)	E3 (mm)	F (mm)	G (mm)	H (mm)	I (mm)	J (mm)	K (mm)	P (mm)
TPAC051230	5	1230	174	1833	1,8	1,8	1,5	30	45	36,6	30	33	40	1275
TPAC051750	5	1750	174	1833	1,8	1,8	1,5	30	45	36,6	30	33	40	1795
TPAC101230	10	1230	324	1814	1,8	1,8	1,5	30	45	36,6	30	33	40	1260
TPAC101750	10	1750	324	1814	1,8	1,8	1,5	30	45	36,6	30	33	40	1775
TPAC151230	15	1230	470	1781	1,8	1,8	1,5	30	45	36,6	30	33	40	1240
TPAC151750	15	1750	470	1781	1,8	1,8	1,5	30	45	36,6	30	33	40	1740
TPAC201230	20	1230	613	1736	1,8	1,8	1,5	30	45	36,6	30	33	40	1210
TPAC201750	20	1750	613	1736	1,8	1,8	1,5	30	45	36,6	30	33	40	1695
TPAC251230	25	1230	752	1679	1,8	1,8	1,5	30	45	36,6	30	33	40	1170
TPAC251750	25	1750	752	1679	1,8	1,8	1,5	30	45	36,6	30	33	40	1640
TPAC301230	30	1230	884	1610	1,8	1,8	1,5	30	45	36,6	30	33	40	1120
TPAC301750	30	1750	884	1610	1,8	1,8	1,5	30	45	36,6	30	33	40	1570
TPAC351230	35	1230	1012	1529	1,8	1,8	1,5	30	45	36,6	30	33	40	1065
TPAC351750	35	1750	1012	1529	1,8	1,8	1,5	30	45	36,6	30	33	40	1490

Drawing

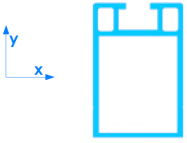

Mechanical properties of the material

	Yield strength F _{y0.2} (N/mm ²)	Ultimate load F _u (N/mm ²)	Elastic modulus E (N/mm ²)	Transverse elastic modulus G (N/mm ²)	Linear expansion coefficient α (μm/C°)	Specific weight ρ (kg/m ³)
EN AW-6063-T6 aluminium	170	215	69.500	26.100	23,5	2.700
A2-70 stainless steel	450	700	210,000	81,000	17.3	7,850

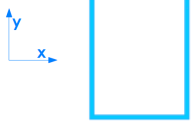
Mechanical properties of the profile.				
	Area S (cm ²)	Moment of inertia I _x (cm ⁴)	Moment of inertia I _y (cm ⁴)	Linear weight W (kg/m)
 <p>Upper profile</p>	2,95	3,96	7,00	0,80
 <p>Lower profile</p>	1,74	1,62	3,87	0,46
 <p>Profile bar</p>	1,65	2,81	3,32	0,45