

## KT-PSE



## HOMOLOGATIONS



## DESCRIPTION DU PRODUIT

Kit de montage triangulaire avec profilé aluminium (**PSE-A**). Fixation assemblée.

## CARACTÉRISTIQUES

- Kit de montage qui regroupe les composants nécessaires pour l'installation d'un nombre déterminé de panneaux solaires.
- Installation selon le système de montage triangulaire **ST-PSE**.
- Comprend pinces de fixation rapides pour panneaux réf. **KFRSC3050**.
- Comprend jauges d'aluminium pour cadre **GM-A**, disponibles en hauteurs de 30, 35 ou 40mm.
- Comprend structure de profilé d'aluminium **PSE-A** en format de profilé continu.
- Comprend raccord de profilés réf. **PSEUN060200**, et visserie pour l'installation **DIN-7504-K A2**.
- Comprend triangles prémontés réglables **TPA-R** avec trois options de réglage de l'inclinaison à 25°, 30° et 35°.
- Comprend connecteurs transversaux pour fixation latérale **KFSFLM08**, pour réaliser l'union des profilés **PSE-A** et des triangles **TPA-R** du kit.

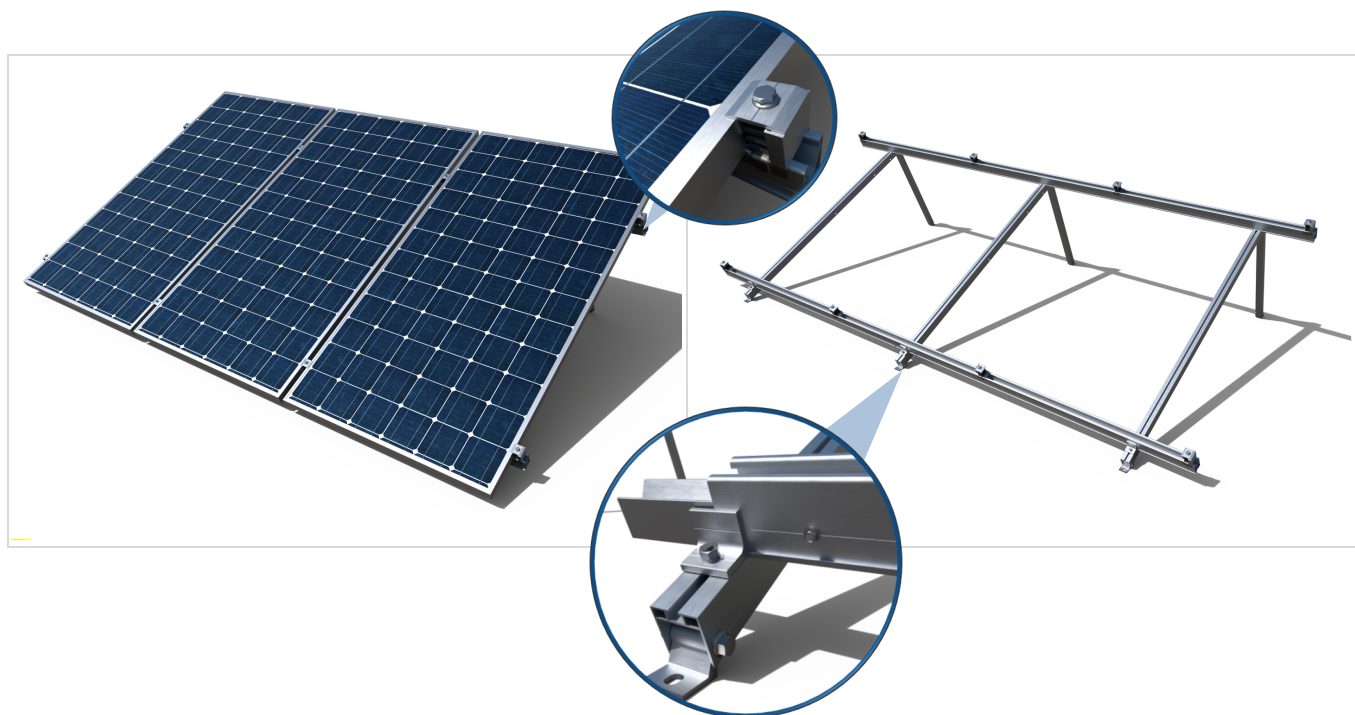



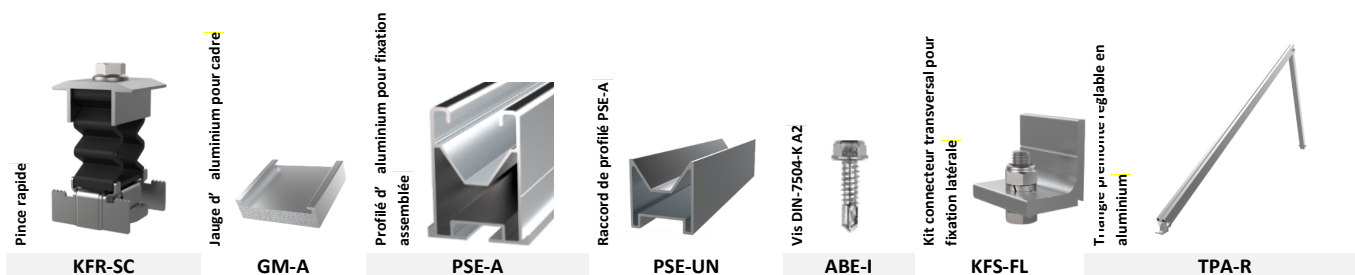









## COMPOSANTS



APPLICATIONS

- Montage de panneaux solaires en disposition inclinée par rapport à la surface de la toiture, sur toitures plates et pente peu prononcée.
- Installation sur tout type de toitures sur triangles préassemblés avec inclinaison réglable à 25°, 30° et 35°.
- Pour panneaux avec cadre de 30, 35 ou 40 mm de hauteur.
- Pour plaques jusqu'à 1150 mm de large
- Orientation de montage des panneaux type portrait (vertical).
- Options de fixation directe à sous-structure de toiture ou fixation assemblée sur structure auxiliaire, consulter les spécificités sur la fiche technique du système de montage **ST-PSE**.









1.GAMME

ITEM	CODE	PHOTO	DESCRIPTION	PANNEAUX	CADRE	L. RAIL	MATÉRIAU		
1	KTPSE0230		Kit triangulaire avec profilé en aluminium PSE-A. Fixation assemblée. Pour 2 panneaux	2	30 mm	2500 mm			
	KTPSE0235			2	35 mm	2500 mm			
	KTPSE0240			2	40 mm	2500 mm			
							Aluminium	AISI-304	EPDM
2	KTPSE0330		Kit triangulaire avec profilé en aluminium PSE-A. Fixation assemblée. Pour 3 panneaux	3	30 mm	3750 mm			
	KTPSE0335			3	35 mm	3750 mm			
	KTPSE0340			3	40 mm	3750 mm			
							Aluminium	AISI-304	EPDM
3	KTPSE02AM		Kit triangulaire avec profil en aluminium (PSE-C). Fixation assemblée. Pour extension 2 panneaux	2	--	2600 mm			
	KTPSE03AM		Kit triangulaire avec profil en aluminium (PSE-C). Fixation assemblée. Pour extension 3 panneaux	3	--	3850 mm			
							Aluminium	AISI-304	EPDM

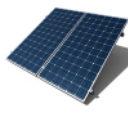
## 2. DONNÉES D'INSTALLATION

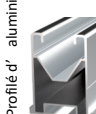
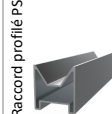
### 2.1 KTPSE02

Kit triangulaire avec profilé en aluminium PSE-A.  
Fixation assemblée. Pour 2 panneaux

  	 <b>2 panneaux</b> <b>Référence</b>	Composants Kit									
		 Pinces rapides	 Jauge d' aluminium pour cadre	 Profilé d' aluminium PSE-A	 Raccord profilé PSE-A	 Vis DIN-7504-K-A2	 Connecteur pour fixation latérale	 Triangle aluminium pré-monté			
		<b>KTPSE0230</b> (H=30mm)	<b>KFRSC3050</b> 6 unités	<b>GMA030</b> 4 unités	<b>PSEA601250</b> 4 unités	<b>PSEUN060200</b> 2 unités	<b>ABEI5519</b> 8 unités	<b>KFSFLM08</b> 8 unités	<b>TPAR251500</b> 2 unités		
		<b>KTPSE0235</b> (H=35mm)	<b>KFRSC3050</b> 6 unités	<b>GMA035</b> 4 unités	<b>PSEA601250</b> 4 unités	<b>PSEUN060200</b> 2 unités	<b>ABEI5519</b> 8 unités	<b>KFSFLM08</b> 8 unités	<b>TPAR251500</b> 2 unités		
<b>KTPSE0240</b> (H=40mm)	<b>KFRSC3050</b> 6 unités	<b>GMA040</b> 4 unités	<b>PSEA601250</b> 4 unités	<b>PSEUN060200</b> 2 unités	<b>ABEI5519</b> 8 unités	<b>KFSFLM08</b> 8 unités	<b>TPAR251500</b> 2 unités				

#### Toiture / compléments de fixation

Consulter la fiche technique correspondante au système de montage ST-PSE.

#### Tableau de dimensions

Code	A (mm)	B (mm)	C (mm)	D (mm)	E (mm)	F (mm)	H (mm)	J (mm)	K (mm)	L (mm)	LF (mm)	M (mm)	T (mm)
KTPSE0230	≤ 1150	≤ 2100	0,5B ÷ 0,7B	0,1B ÷ 0,25B	26	≥ 35	30	1400÷1600	(LF-J) / 2	1250	2500	(T-C) / 2	1500
KTPSE0235	≤ 1150	≤ 2100	0,5B ÷ 0,7B	0,1B ÷ 0,25B	26	≥ 35	35	1400÷1600	(LF-J) / 2	1250	2500	(T-C) / 2	1500
KTPSE0240	≤ 1150	≤ 2100	0,5B ÷ 0,7B	0,1B ÷ 0,25B	26	≥ 35	40	1400÷1600	(LF-J) / 2	1250	2500	(T-C) / 2	1500

#### Dessin



Tableau de dimensions 2

Code	Position 1			Position 2			Position 3		
	$\beta$ (°)	Ls (mm)	Lb (mm)	$\beta$ (°)	Ls (mm)	Lb (mm)	$\beta$ (°)	Ls (mm)	Lb (mm)
TPAR251500	25	18	1696	30	118	1260	35	293	1052

Dessin



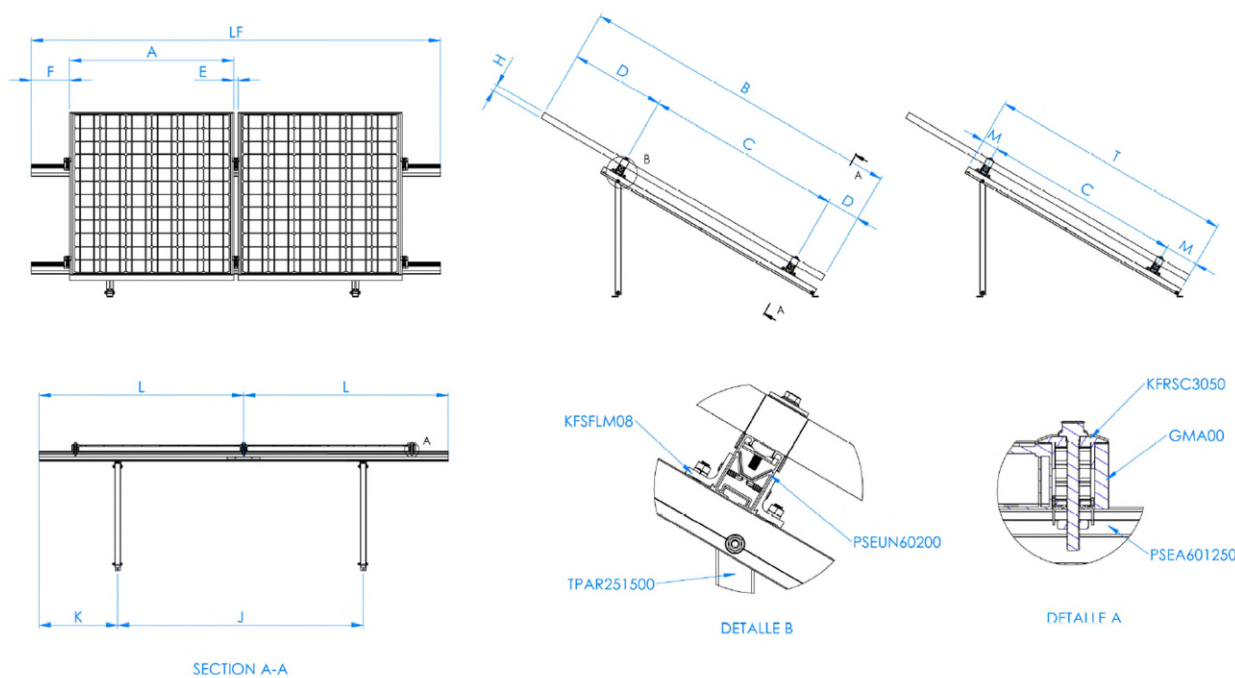
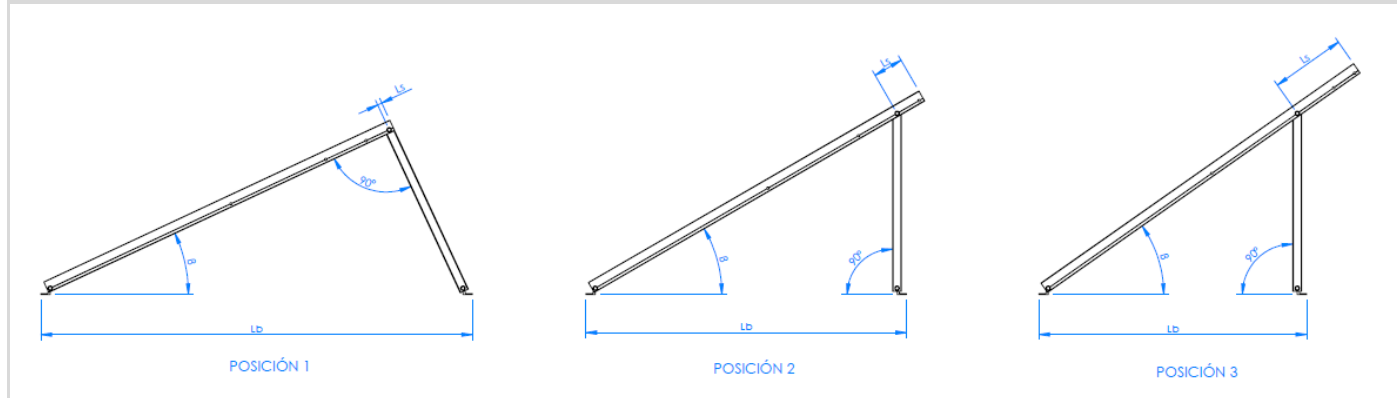



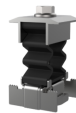

Propriétés mécaniques profilés.

	Zone S (cm <sup>2</sup> )	Mmt. d'inertie I <sub>x</sub> (cm <sup>4</sup> )	Mmt. d'inertie I <sub>y</sub> (cm <sup>4</sup> )	Mmt. résistance W <sub>x</sub> (cm <sup>3</sup> )	Mmt. résistance W <sub>y</sub> (cm <sup>3</sup> )	Poids linéaire W (kg/m)
 Profilé supérieur	3,01	5,15	7,52	1,76	3,76	0,81
 Profilé patte	2,59	4,66	4,66	2,66	2,66	0,70
 Profilé Pied	3,91	3,99	4,66	1,94	1,61	1,04

## 2.2 KTPSE03

### Kit triangulaire avec profilé aluminium PSE-A. Fixation assemblée. Pour 3 panneaux

	Composants Kit						
	 Pinces rapides Référence KTPSE0330 (H=30mm) KTPSE0335 (H=35mm) KTPSE0340 (H=40mm)	 Jauge d' aluminium pour cadre Référence KFRSC3050	 GMA030 Référence GMA030	 Profilé d' aluminium PSE-A Référence PSEA601875	 Raccord profilé PSE-A Référence PSEUN060200	 Vis DIN-7504-K A2 Référence ABEI5519	 Connecteur pour fixation latérale Référence KFSFLM08

#### Toiture / compléments de fixation

Consulter la fiche technique correspondante au système de montage ST-PSE.

#### Tableau de dimensions

Code	A (mm)	B (mm)	C (mm)	D (mm)	E (mm)	F (mm)	G (mm)	H (mm)	J (mm)	K (mm)	L (mm)	LF (mm)	LU (mm)	M (mm)	T (mm)
KTPSE0330	≤ 1150	≤ 2100	0,5B ÷ 0,7B	0,1B ÷ 0,25B	26	≥ 35	50÷70	30	1300÷1500	(LF-2J) / 2	1875	3750	200	(T-C) / 2	1500
KTPSE0335	≤ 1150	≤ 2100	0,5B ÷ 0,7B	0,1B ÷ 0,25B	26	≥ 35	50÷70	35	1300÷1500	(LF-2J) / 2	1875	3750	200	(T-C) / 2	1500
KTPSE0340	≤ 1150	≤ 2100	0,5B ÷ 0,7B	0,1B ÷ 0,25B	26	≥ 35	50÷70	40	1300÷1500	(LF-2J) / 2	1875	3750	200	(T-C) / 2	1500

#### Dessin



Tableau de dimensions 2

Code	Position 1			Position 2			Position 3		
	$\beta$ (°)	Ls (mm)	Lb (mm)	$\beta$ (°)	Ls (mm)	Lb (mm)	$\beta$ (°)	Ls (mm)	Lb (mm)
TPAR251500	25	18	1696	30	118	1260	35	293	1052

Dessin



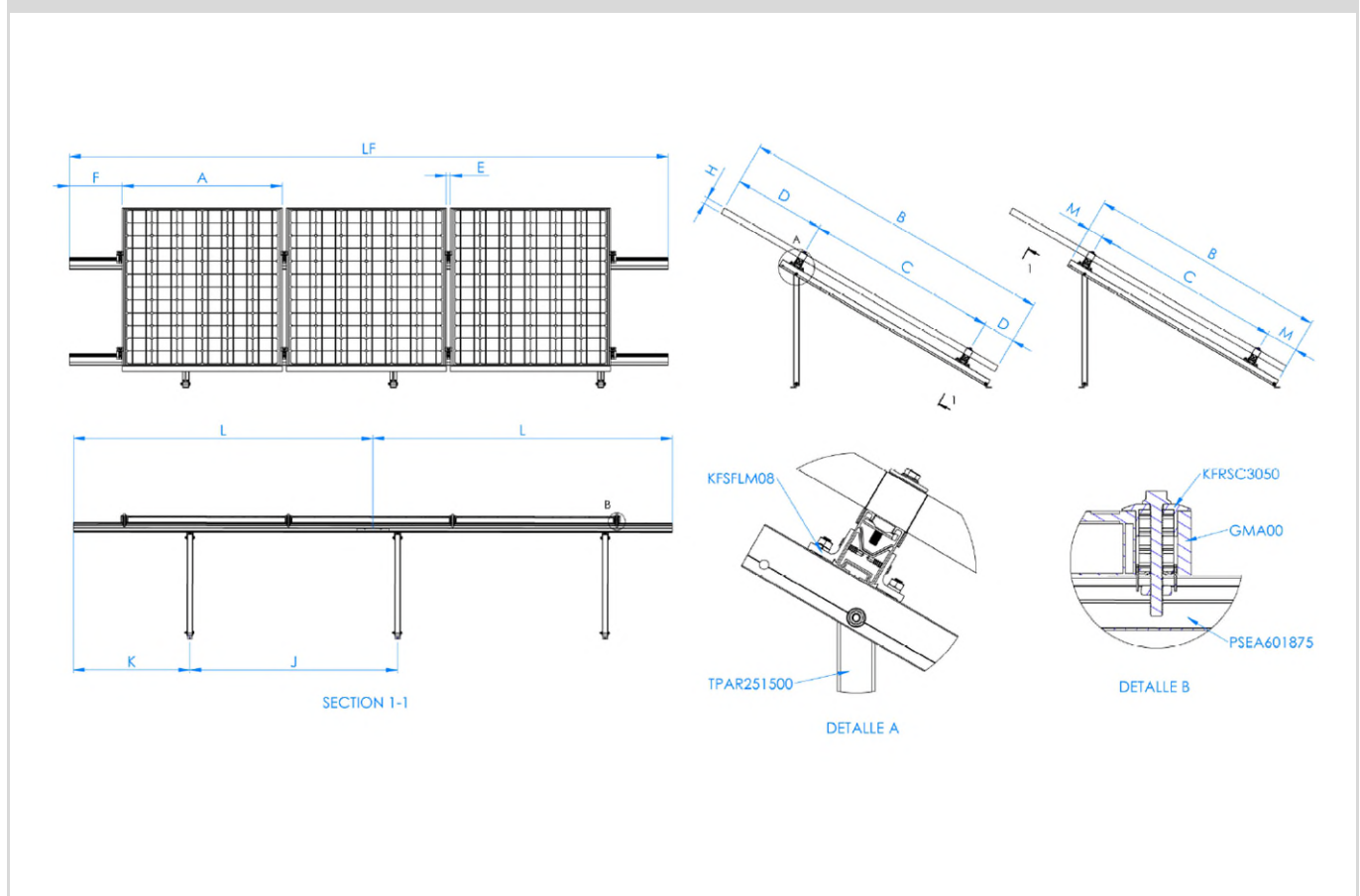
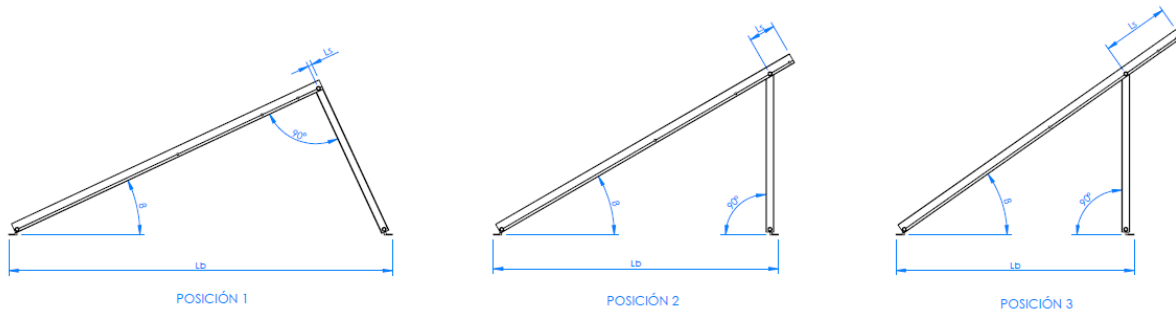







Propriétés mécaniques profilés.

	Zone S (cm <sup>2</sup> )	Mmt. d'inertie I <sub>x</sub> (cm <sup>4</sup> )	Mmt. d'inertie I <sub>y</sub> (cm <sup>4</sup> )	Mmt. résistance W <sub>x</sub> (cm <sup>3</sup> )	Mmt. résistance W <sub>y</sub> (cm <sup>3</sup> )	Poids linéaire W (kg/m)
 Profilé supérieur	3,01	5,15	7,52	1,76	3,76	0,81
 Profilé patte	2,59	4,66	4,66	2,66	2,66	0,70
 Profilé Pied	3,91	3,99	4,66	1,94	1,61	1,04

## 2.3 KTPSEAM

### Kit d'extension triangulaire avec profil en aluminium (PSE-A). Fixation assemblée. Pour 2 et 3 panneaux

	 <p><b>2 &amp; 3 panneaux</b></p>	Composants Kit					
		 Pinces rapides 4 unités	 Profilé d' aluminium PSE-A 4 unités	 Raccord profilé PSE-A 4 unités	 Vis DIN-7504-K A2 16 unités	 Connecteur pour fixation latérale 8 unités	 Triangle aluminium pré-monté 2 unités
<b>KTPSE02AM</b>	<b>KFRSC3050</b> 4 unités	<b>PSEA601250</b> 4 unités	<b>PSEUN060200</b> 4 unités	<b>ABEI5519</b> 16 unités	<b>KFSFLM08</b> 8 unités	<b>TPAR251500</b> 2 unités	
<b>KTPSE03AM</b>	<b>KFRSC3050</b> 6 unités	<b>PSEA601875</b> 4 unités	<b>PSEUN060200</b> 4 unités	<b>ABEI5519</b> 16 unités	<b>KFSFLM08</b> 12 unités	<b>TPAR251500</b> 3 unités	

#### Toiture / compléments de fixation

Consulter la fiche technique correspondante au système de montage ST-PSE.

#### Tableau de dimensions

Code	A (mm)	B (mm)	C (mm)	D (mm)	E (mm)	F (mm)	G (mm)	J (mm)	K (mm)	L (mm)	LF (mm)	LU (mm)	M (mm)	T (mm)
KTPSE02AM	≤ 1150	≤ 2100	0,5B ÷ 0,7B	0,1B ÷ 0,25B	26	≥ 35	50÷70	1300÷1500	(LF-2I) / 2	1250	2600	200	(T-C) / 2	1500
KTPSE03AM	≤ 1150	≤ 2100	0,5B ÷ 0,7B	0,1B ÷ 0,25B	26	≥ 35	50÷70	1300÷1500	(LF-2I) / 2	1875	3850	200	(T-C) / 2	1500

#### Dessin

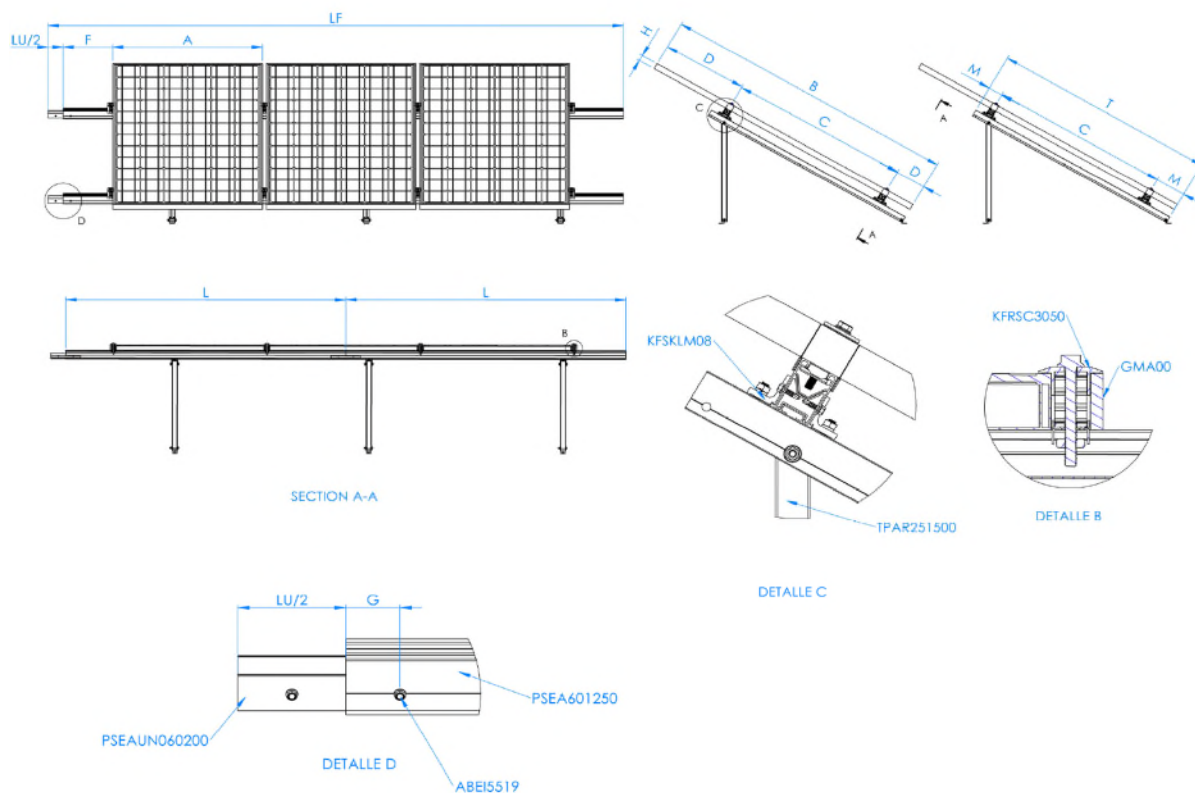

#### Exemple de composition du kit d'extension 3 panneaux

Tableau de dimensions 2

Code	Position 1			Position 2			Position 3		
	$\beta$ (°)	Ls (mm)	Lb (mm)	$\beta$ (°)	Ls (mm)	Lb (mm)	$\beta$ (°)	Ls (mm)	Lb (mm)
TPAR251500	25	18	1696	30	118	1260	35	293	1052

Dessin

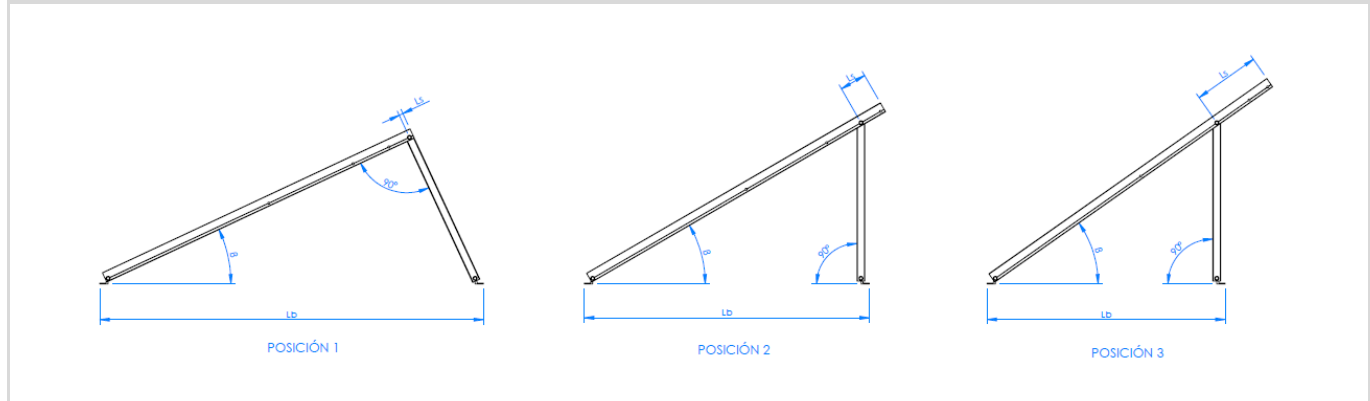

Propriétés mécaniques profilés.

	Zone S (cm <sup>2</sup> )	Mmt. d'inertie I <sub>x</sub> (cm <sup>4</sup> )	Mmt. d'inertie I <sub>y</sub> (cm <sup>4</sup> )	Mmt. résistance W <sub>x</sub> (cm <sup>3</sup> )	Mmt. résistance W <sub>y</sub> (cm <sup>3</sup> )	Poids linéaire W (kg/m)
 Profilé supérieur	3,01	5,15	7,52	1,76	3,76	0,81
 Profilé patte	2,59	4,66	4,66	2,66	2,66	0,70
 Profilé Pied	3,91	3,99	4,66	1,94	1,61	1,04