

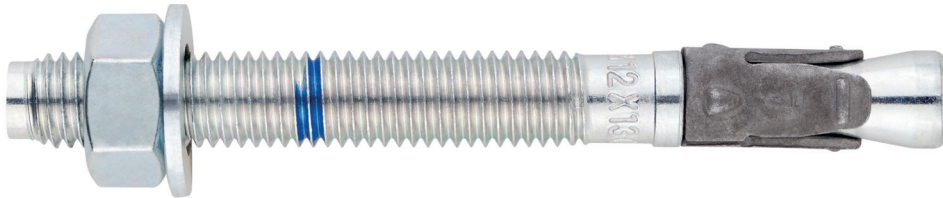

## Through-bolt expansion anchor with controlled torque, for use in cracked and non cracked concrete

**MTP-X**

ETA Assessed Option 1. Zinc-plated shaft. Sherardized clip.



### PRODUCT INFORMATION

#### DESCRIPTION

Metallic anchor, with male thread, expansion by controlled torque.

#### OFFICIAL DOCUMENTATION

- AVCP-1219-CPR-0053.
- ETA 12/0397 option 1.
- Declaration of Performance DoP MTP.

#### SIZES

M8x50 to M20x200.

#### DESIGN LOAD RANGE

From 5,6 to 32,8 kN [non-cracked].  
From 3,9 to 23,0 kN [cracked].



#### BASE MATERIAL

Concrete class from C20/25 to C50/60  
cracked or non-cracked.



Stone



Concrete



Reinforced Concrete



Cracked concrete

#### ASSESSMENTS

- Option 1 [Cracked or non-cracked concrete].
- Fire Resistance R30-120
- Seismic C1 M8÷M20
- Seismic C2 M10, M12 and M20

STRUCTURAL FIXINGS IN  
CRACKED & UNCRACKED CONCRETE

#### CHARACTERISTICS AND BENEFITS

- Easy installation.
- Use in cracked and non-cracked concrete.
- Use for medium-heavy duty loads.
- Pre-Installation, or through the drill-hole of the fixture.
- Variety of lengths and diameters: flexibility in assembly.
- For static and quasi-static loads.
- Length mark on top of shaft for easy inspection and quality control.
- Available in INDEXcal.



#### MATERIALES

Shaft: Carbon steel, zinc plated  $\geq 5 \mu\text{m}$ .

Washer: DIN 125 or DIN 9021, zinc plated  $\geq 5 \mu\text{m}$ .

Nut: DIN 934, zinc plated  $\geq 5 \mu\text{m}$ .

Clip: Carbon steel, sherardized  $\geq 40 \mu\text{m}$ .



#### APPLICATIONS

- Anchor plates.
- Metallic structures.
- Bridges.
- Urban fitments.
- Protective fences.
- Catenaries.
- Elevators.
- Pipe supports.

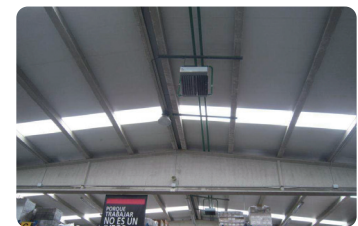



**MECHANICAL PROPERTIES**

			M8	M10	M12	M16	M20
<b>Cone area section</b>							
$A_s$	(mm <sup>2</sup> )	Cone area section	22,9	41,8	55,4	103,9	176,7
$f_{u,s}$	(N/mm <sup>2</sup> )	Characteristic tension resistance	790	750	730	700	660
$f_{y,s}$	(N/mm <sup>2</sup> )	Yield strength	632	600	585	560	530
<b>Threaded area section</b>							
$A_s$	(mm <sup>2</sup> )	Cone area section	36,6	58,0	84,3	157,0	245,0
$f_{u,s}$	(N/mm <sup>2</sup> )	Characteristic tension resistance	600	600	600	600	600
$f_{y,s}$	(N/mm <sup>2</sup> )	Yield Strength	480	480	480	480	480

**INSTALLATION DATA**

SIZE			M8	M10	M12	M16	M20
Code			APX08XXX	APX10XXX	APX12XXX	APX16XXX	APX20XXX
$d_0$	Nominal diameter of drill bit	[mm]	8	10	12	16	20
$T_{ins}$	Installation torque moment	[Nm]	15	40	60	100	200
$d_{t\leq}$	Diameter of clearance hole in the fixture	[mm]	9	12	14	18	22
$h_1$	Minimum drill hole depth	[mm]	60	75	85	105	125
$h_{nom}$	Installation depth	[mm]	55	68	80	97	114
$h_{ef}$	Effective embedment depth	[mm]	48	60	70	85	100
$h_{min}$	Minimum base material thickness	[mm]	100	120	140	170	200
$t_{fix}$	Maximum thickness of fixture	[mm]	L - 66	L - 80	L - 96	L - 117	L-138
$s_{cr,N}$	Critical spacing	[mm]	144	180	210	255	300
$c_{cr,N}$	Critical edge distance	[mm]	72	90	105	128	150
$s_{cr,sp}$	Critical distance (splitting)	[mm]	288	300	350	510	600
$c_{cr,sp}$	Critical edge distance (splitting)	[mm]	144	150	175	255	300
$s_{min}$	Minimum spacing	[mm]	40	40	60	65	95
		[mm]	55	70	75	95	105
$c_{min}$	Minimum edge distance	[mm]	45	45	55	70	95
		[mm]	55	90	110	115	105
<b>SW</b>	Installation wrench		13	17	19	24	30

\*L = Total anchor length

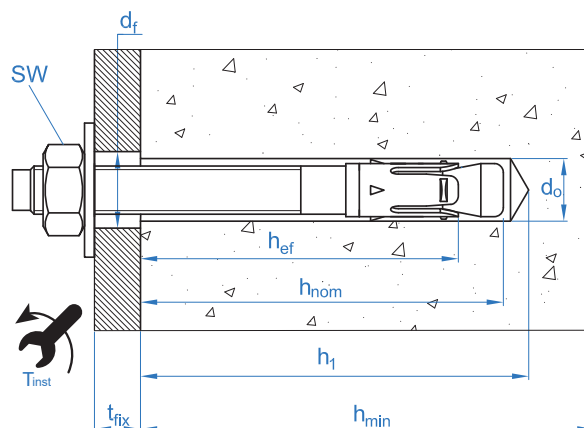



Code	INSTALLATION PRODUCTS
	Hammer drill
BHDSXXXXX	Concrete Drill bits
MOBOMBA	Blow pump
MORCEPKIT	Cleaning Brush
DOMTAXX	Installation hammering tool
	Torque wrench
	Hexagonal socket

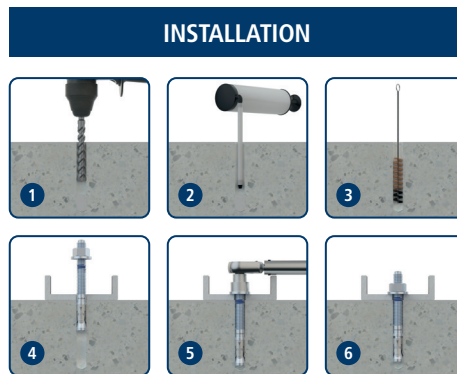

## Resistances in C20/25 concrete for an isolated anchor, without effects of edge distance or spacing

Characteristic Resistance $N_{Rk}$ and $V_{Rk}$													
TENSION							SHEAR						
Size		M8	M10	M12	M16	M20	Size		M8	M10	M12	M16	M20
$N_{Rk}$	Non-cracked concrete [kN]	10,0	18,0	28,0	34,0	49,2	$V_{Rk}$	Non-cracked concrete [kN]	11,0	17,4	25,3	47,1	73,1
$N_{Rk}$	Cracked concrete [kN]	7,0	11,0	15,0	27,0	34,4	$V_{Rk}$	Cracked concrete [kN]	11,5	17,4	25,3	27,1	73,1

Design Resistance $N_{Rd}$ and $V_{Rd}$													
TENSION							SHEAR						
Size		M8	M10	M12	M16	M20	Size		M8	M10	M12	M16	M20
$N_{Rd}$	Non-cracked concrete [kN]	5,6	12,0	18,7	22,7	32,8	$V_{Rd}$	Non-cracked concrete [kN]	8,8	13,9	20,2	37,7	58,5
$N_{Rd}$	Cracked concrete [kN]	3,9	7,3	10,0	18,0	23,0	$V_{Rd}$	Cracked concrete [kN]	9,2	13,9	20,2	21,7	58,5

Maximum Loads Recommended $N_{rec}$ and $V_{rec}$													
TENSION							SHEAR						
Size		M8	M10	M12	M16	M20	Size		M8	M10	M12	M16	M20
$N_{rec}$	Non-cracked concrete [kN]	4,0	8,6	13,3	16,2	23,4	$V_{rec}$	Non-cracked concrete [kN]	6,3	9,9	14,5	26,9	41,8
$N_{rec}$	Cracked concrete [kN]	2,8	5,2	7,1	12,9	16,4	$V_{rec}$	Cracked concrete [kN]	6,5	9,9	14,5	15,5	41,8

## Simplified calculation method

### European Technical Assessment ETA 12/0397

Simplified version of the calculation method according to Eurocode 2 EN 1992-4. Resistance is calculated according to the data shown in assessment 12/0397.

- Influence of concrete strength.
- Influence of edge distance.
- Influence of spacing between anchors.
- Influence of reinforcements.
- Influence of base material thickness.
- Influence of load application angle.
- Valid for a group of two anchors.



### INDEXcal

For a more accurate calculation and to take more constructive provisions into account, we recommend using our calculation program INDEXcal. It may be easily downloaded from our website [www.indexfix.com](http://www.indexfix.com)

# MTP-X

## TENSION LOADS

- Steel design resistance:  $N_{Rd,s}$
- Pull-out design resistance:  $N_{Rd,p} = N_{Rd,p}^o \cdot \psi_c$
- Concrete cone design resistance:  $N_{Rd,c} = N_{Rd,c}^o \cdot \psi_b \cdot \psi_{s,N} \cdot \psi_{c,N} \cdot \psi_{re,N}$
- Concrete splitting design resistance:  $N_{Rd,sp} = N_{Rd,c}^o \cdot \psi_b \cdot \psi_{s,sp} \cdot \psi_{c,sp} \cdot \psi_{re,N} \cdot \psi_{h,sp}$

Steel Design resistance						
$N_{Rd,s}$						
Size		M8	M10	M12	M16	M20
$N_{Rd}^o$	[kN]	12,1	20,9	26,9	48,5	77,7

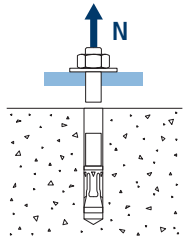

Pull-out design resistance							
$N_{Rd,p} = N_{Rd,p}^o \cdot \psi_c$							
Size		M8	M10	M12	M16	M20	
$N_{Rd,p}^o$	Non-cracked concrete	[kN]	5,56	12,00	18,67	22,67	32,80
$N_{Rd,p}^o$	Cracked concrete	[kN]	3,89	7,33	10,00	17,99	22,96

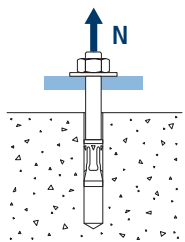

Concrete cone design resistance							
$N_{Rd,c} = N_{Rd,c}^o \cdot \psi_b \cdot \psi_{s,N} \cdot \psi_{c,N} \cdot \psi_{re,N}$							
Concrete splitting design resistance*							
$N_{Rd,sp} = N_{Rd,c}^o \cdot \psi_b \cdot \psi_{s,sp} \cdot \psi_{c,sp} \cdot \psi_{re,N} \cdot \psi_{h,sp}$							
Size		M8	M10	M12	M16	M20	
$N_{Rd,c}^o$	Non-cracked concrete	[kN]	9,1	15,2	19,2	25,7	32,8
$N_{Rd,c}^o$	Cracked concrete	[kN]	6,4	10,7	13,5	18,0	23,0

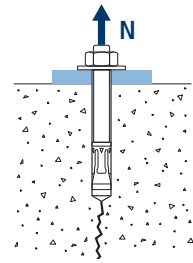
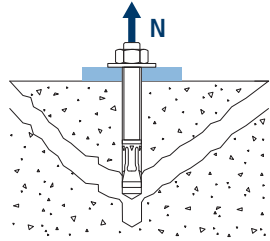

\*Concrete splitting design resistance must only be considered for non-cracked concrete.



## MTP-X

## Coefficients of influence

Influence of concrete strength resistance in pul-out failure  $\Psi_c$ 

		M8	M10	M12	M16	M20
$\Psi_c$	C 20/25	1,00				
	C 30/37	1,22	1,17	1,22	1,22	1,17
	C 40/50	1,41	1,31	1,41	1,41	1,31
	C 50/60	1,58	1,43	1,58	1,58	1,43

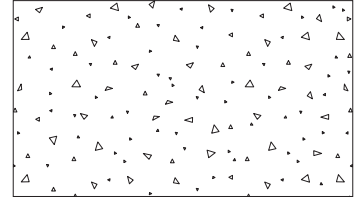
Influence of concrete strength in concret cone and splitting failure  $\Psi_b$ 

		M8	M10	M12	M16	M20
$\Psi_b$	C 20/25	1,00				
	C 30/37	1,22				
	C 40/50	1,41				
	C 50/60	1,58				

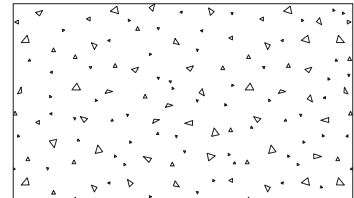

$$\Psi_b = \sqrt{\frac{f_{ck,cube}}{25}} \geq 1$$



**MTP-X**



$$\psi_{s,N} = 0,5 + \frac{s}{2 \cdot s_{cr,N}} \leq 1$$

Influence of spacing (concrete cone) $\psi_{s,N}$					
s [mm]	MTP-X				
	M8	M10	M12	M16	M20
40	0,64	0,61			
50	0,67	0,64			
55	0,69	0,65			
60	0,71	0,67	0,64		
65	0,73	0,68	0,65	0,63	
70	0,74	0,69	0,67	0,64	
80	0,78	0,72	0,69	0,66	
85	0,80	0,74	0,70	0,67	
90	0,81	0,75	0,71	0,68	
95	0,83	0,76	0,73	0,69	
100	0,85	0,78	0,74	0,70	
105	0,86	0,79	0,75	0,71	
110	0,88	0,81	0,76	0,72	
120	0,92	0,83	0,79	0,74	
125	0,93	0,85	0,80	0,75	0,71
126	0,94	0,85	0,80	0,75	0,71
128	0,94	0,86	0,80	0,75	0,71
130	0,95	0,86	0,81	0,75	0,72
135	0,97	0,88	0,82	0,76	0,73
144	1,00	0,90	0,84	0,78	0,74
150		0,92	0,86	0,79	0,75
165		0,96	0,89	0,82	0,78
170		0,97	0,90	0,83	0,78
180		1,00	0,93	0,85	0,80
195			0,96	0,88	0,83
200			0,98	0,89	0,83
210			1,00	0,91	0,85
220				0,93	0,87
225				0,94	0,88
252				0,99	0,92
255				1,00	0,93
260					0,93
300					1,00

Invalid value

Value without reduction = 1



Influence of spacing (concrete splitting) $\psi_{s,sp}$						
s [mm]	MTP-X					
	M8	M10	M12	M16	M20	
40	0,57	0,57	Invalid value			
50	0,59	0,58				
55	0,60	0,59				
60	0,60	0,60	0,59	Invalid value		
65	0,61	0,61	0,59			0,56
70	0,62	0,62	0,60			0,57
80	0,64	0,63	0,61	0,58	Invalid value	
85	0,65	0,64	0,62	0,58		
90	0,66	0,65	0,63	0,59		
95	0,66	0,66	0,64	0,59	0,58	
100	0,67	0,67	0,64	0,60	0,58	
110	0,69	0,68	0,66	0,61	0,59	
125	0,72	0,71	0,68	0,62	0,60	
128	0,72	0,71	0,68	0,63	0,61	
135	0,73	0,73	0,69	0,63	0,61	
140	0,74	0,73	0,70	0,64	0,62	
150	0,76	0,75	0,71	0,65	0,63	
160	0,78	0,77	0,73	0,66	0,63	
165	0,79	0,78	0,74	0,66	0,64	
168	0,79	0,78	0,74	0,66	0,64	
180	0,81	0,80	0,76	0,68	0,65	
192	0,83	0,82	0,77	0,69	0,66	
200	0,85	0,83	0,79	0,70	0,67	
210	0,86	0,85	0,80	0,71	0,68	
220	0,88	0,87	0,81	0,72	0,68	
260	0,95	0,93	0,87	0,75	0,72	
280	0,99	0,97	0,90	0,77	0,73	
288	1,00	0,98	0,91	0,78	0,74	
300	Value without reduction = 1		0,93	0,79	0,75	
336			0,98	0,83	0,78	
350			1,00	0,84	0,79	
360	Value without reduction = 1		Value without reduction = 1		0,85	0,80
412					0,90	0,84
425					0,92	0,85
500	Value without reduction = 1		Value without reduction = 1		0,99	0,92
510					1,00	0,93
560					Value without reduction = 1	
600	1,00					

MTP-X

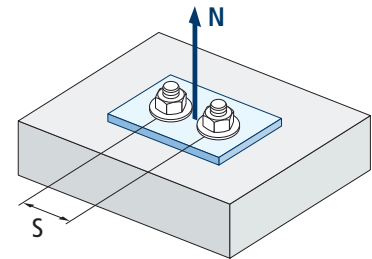

$$\psi_{s,sp} = 0,5 + \frac{s}{2 \cdot s_{cr,sp}} \leq 1$$



# MTP-X

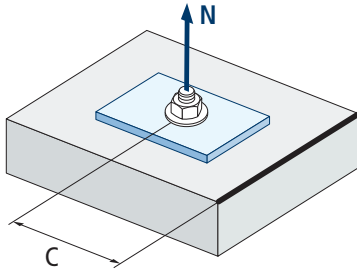

$$\psi_{c,sp} = 0,35 + \frac{0,5 \cdot c}{C_{cr,sp}} + \frac{0,15 \cdot c^2}{C_{cr,sp}^2} \leq 1$$

Influence of concrete edge distance (splitting) $\psi_{c,sp}$					
c [mm]	MTP-X				
	M8	M10	M12	M16	M20
45	0,52	0,51			
50	0,54	0,53			
55	0,56	0,55	0,52		
60	0,58	0,57	0,54		
65	0,61	0,59	0,56		
70	0,63	0,62	0,57	0,50	
75	0,65	0,64	0,59	0,51	
80	0,67	0,66	0,61	0,52	
83	0,69	0,67	0,62	0,53	
84	0,69	0,68	0,62	0,53	
85	0,70	0,68	0,63	0,53	
90	0,72	0,70	0,65	0,55	
95	0,75	0,73	0,67	0,56	0,52
100	0,77	0,75	0,68	0,57	0,53
105	0,79	0,77	0,70	0,58	0,54
110	0,82	0,80	0,72	0,59	0,55
125	0,90	0,87	0,78	0,63	0,58
128	0,91	0,89	0,80	0,64	0,59
130	0,92	0,90	0,80	0,64	0,59
135	0,95	0,92	0,82	0,66	0,61
140	0,98	0,95	0,85	0,67	0,62
144	1,00	0,97	0,86	0,68	0,62
150		1,00	0,89	0,70	0,64
168			0,97	0,74	0,68
175			1,00	0,76	0,69
180				0,78	0,70
206				0,85	0,76
213				0,87	0,78
250				0,98	0,87
255				1,00	0,88
280					0,95
300					1,00

Value without reduction = 1

Invalid value





Influence of concrete edge distance (concrete cone) $\psi_{c,N}$							
c [mm]	MTP-X						
	M8	M10	M12	M16	M20		
40	0,67	0,60	Invalid value				
50	0,77	0,67					
53	0,80	0,70					
60	0,87	0,75					
63	0,90	0,77					
65	0,92	0,79				0,72	
70	0,98	0,83				0,75	
72	1,00	0,85				0,76	
75		0,87				0,78	
80		0,91				0,82	
83		0,94				0,84	
85		0,96				0,85	
90		1,00				0,89	
95						0,93	0,80
100						0,96	0,83
105			1,00	0,86			
110				0,89			
113				0,91			
125				0,98	0,87		
126				0,99	0,88		
128				1,00	0,89		
135					0,92		
150					1,00		

Value without reduction = 1

**MTP-X**

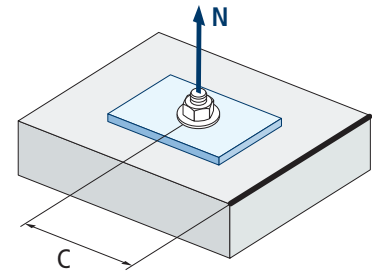

$$\psi_{c,N} = 0,35 + \frac{0,5 \cdot c}{C_{cr,N}} + \frac{0,15 \cdot c^2}{C_{cr,N}^2} \leq 1$$

Influence of reinforcements $\psi_{re,N}$					
$\psi_{re,N}$	MTP-X				
	M8	M10	M12	M16	M20
	0,74	0,80	0,85	0,93	1,00

\*This factor only applies for a high density of reinforcements. If in the area of the anchor there are reinforcements with a distancing of  $\geq 150$  mm (any diameter) or with a diameter  $\leq 10$  mm and a distancing of  $\geq 100$  mm, a  $f_{re,N} = 1$  factor may be applied.

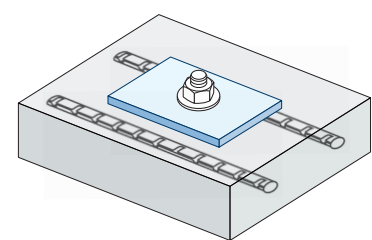

$$\psi_{re,N} = 0,5 + \frac{h_{ef}}{200} \leq 1$$

Influence of base material thickness $\psi_{h,sp}$											
$\psi_{h,sp}$	MTP-X										
	h/h <sub>ef</sub>	2,00	2,20	2,40	2,60	2,80	3,00	3,20	3,40	3,60	$\geq 3,68$
	$\psi_{h,sp}$	1,00	1,07	1,13	1,19	1,25	1,31	1,37	1,42	1,48	1,50

$$\psi_{h,sp} = \left( \frac{h}{2 \cdot h_{ef}} \right)^{2/3} \leq 1,5$$

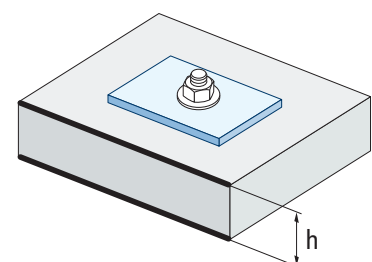

# MTP-X

## SHEAR LOADS

- Steel design resistance without lever arm:  $V_{Rd,s}$
- Pry-out design resistance:  $V_{Rd,cp} = k \cdot N_{Rd,c}^o$
- Concrete edge design resistance:  $V_{Rd,c} = V_{Rd,c}^o \cdot \psi_b \cdot \psi_{se,V} \cdot \psi_{c,V} \cdot \psi_{re,V} \cdot \psi_{\alpha,V} \cdot \psi_{h,V}$

Steel design resistance						
$V_{Rd,s}$						
Size		M8	M10	M12	M16	M20
$V_{Rd,s}$	[kN]	8,8	13,9	20,2	37,7	58,5

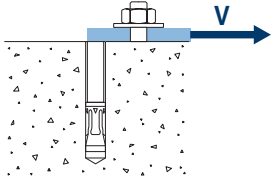

Pry-out design resistance*						
$V_{Rd,cp} = k \cdot N_{Rd,c}^o$						
Size		M8	M10	M12	M16	M20
k		1	2	2	2	2

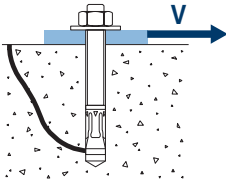

\*  $N_{Rd,c}^o$  Concrete cone design resistance for tension loads

Concrete edge resistance							
$V_{Rd,c} = V_{Rd,c}^o \cdot \psi_b \cdot \psi_{se,V} \cdot \psi_{c,V} \cdot \psi_{re,V} \cdot \psi_{\alpha,V} \cdot \psi_{h,V}$							
Size		M8	M10	M12	M16	M20	
$V_{Rd,c}^o$	Non-cracked concrete	[kN]	6,2	8,9	11,5	15,9	20,8
	Cracked concrete	[kN]	4,4	6,3	8,2	11,3	14,7

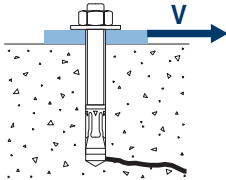



MTP-X

## Coefficients of influence

Influence of concrete strength in concrete edge failure  $\Psi_b$ 

		M8	M10	M12	M16	M20
$\Psi_b$	C 20/25	1,00				
	C 30/37	1,22				
	C 40/50	1,41				
	C 50/60	1,55				

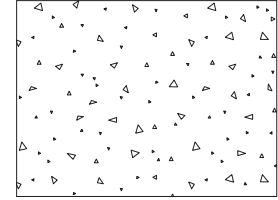

$$\Psi_b = \sqrt{\frac{f_{ck,cube}}{25}} \geq 1$$

Influence of edge distance and spacing  $\Psi_{se,V}$ 

FOR ONE ANCHOR ONLY

$c/h_{ef}$	0,50	0,75	1,00	1,25	1,50	1,75	2,00	2,25	2,50	2,75	3,00	3,25	3,50	3,75	4,00	4,50	5,00
Isolated	0,35	0,65	1,00	1,40	1,84	2,32	2,83	3,38	3,95	4,56	5,20	5,86	6,55	7,26	8,00	9,55	11,18

FOR TWO ANCHORS

$c/h_{ef}$	0,50	0,75	1,00	1,25	1,50	1,75	2,00	2,25	2,50	2,75	3,00	3,25	3,50	3,75	4,00	4,50	5,00	
s/c	1,0	0,24	0,43	0,67	0,93	1,22	1,54	1,89	2,25	2,64	3,04	3,46	3,91	4,37	4,84	5,33	6,36	7,45
	1,5	0,27	0,49	0,75	1,05	1,38	1,74	2,12	2,53	2,96	3,42	3,90	4,39	4,91	5,45	6,00	7,16	8,39
	2,0	0,29	0,54	0,83	1,16	1,53	1,93	2,36	2,81	3,29	3,80	4,33	4,88	5,46	6,05	6,67	7,95	9,32
	2,5	0,32	0,60	0,92	1,28	1,68	2,12	2,59	3,09	3,62	4,18	4,76	5,37	6,00	6,66	7,33	8,75	10,25
	≥3,0	0,35	0,65	1,00	1,40	1,84	2,32	2,83	3,38	3,95	4,56	5,20	5,86	6,55	7,26	8,00	9,55	11,18

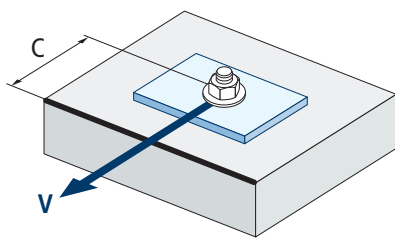

$$\Psi_{se,V} = \left(\frac{c}{h_{ef}}\right)^{1,5}$$

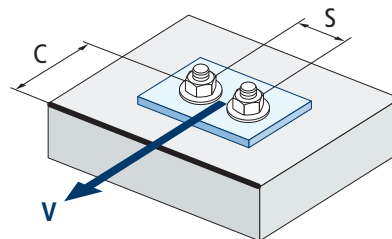

$$\Psi_{se,V} = \left(\frac{c}{h_{ef}}\right)^{1,5} \cdot \left(1 + \frac{s}{3 \cdot c}\right) \cdot 0,5 \leq \left(\frac{c}{h_{ef}}\right)^{1,5}$$



**MTP-X**

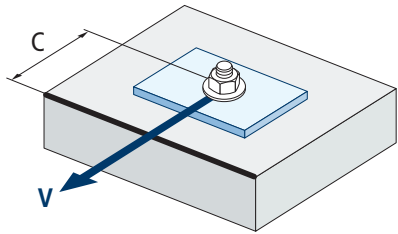

$$\psi_{c,v} = \left( \frac{d}{c} \right)^{0,20}$$

Influence of concrete edge distance $\psi_{c,v}$					
c [mm]	MTP-X				
	M8	M10	M12	M16	M20
40					
45					
50	0,69				
55	0,68				
60	0,67	0,70			
65	0,66	0,69	0,71		
70	0,65	0,68	0,70		
80	0,63	0,66	0,68		
85	0,62	0,65	0,68	0,72	
90	0,62	0,64	0,67	0,71	
100	0,60	0,63	0,65	0,69	0,72
105	0,60	0,62	0,65	0,69	0,72
110	0,59	0,62	0,64	0,68	0,71
120	0,58	0,61	0,63	0,67	0,70
125	0,58	0,60	0,63	0,66	0,69
130	0,57	0,60	0,62	0,66	0,69
135	0,57	0,59	0,62	0,65	0,68
140	0,56	0,59	0,61	0,65	0,68
150	0,56	0,58	0,60	0,64	0,67
160	0,55	0,57	0,60	0,63	0,66
170	0,54	0,57	0,59	0,62	0,65
175	0,54	0,56	0,59	0,62	0,65
180	0,54	0,56	0,58	0,62	0,64
190	0,53	0,55	0,58	0,61	0,64
200	0,53	0,55	0,57	0,60	0,63
210	0,52	0,54	0,56	0,60	0,62
220	0,52	0,54	0,56	0,59	0,62
230	0,51	0,53	0,55	0,59	0,61
240	0,51	0,53	0,55	0,58	0,61
250	0,50	0,53	0,54	0,58	0,60
260	0,50	0,52	0,54	0,57	0,60
270	0,49	0,52	0,54	0,57	0,59
280	0,49	0,51	0,53	0,56	0,59
290	0,49	0,51	0,53	0,56	0,59
300	0,48	0,51	0,53	0,56	0,58



Influence of reinforcements $\Psi_{re,v}$			
	Without perimetral reinforcements	Perimetral reinforcements $\geq \text{Ø}12 \text{ mm}$	Perimetral reinforcements with brackets $\leq 100 \text{ mm}$
Non-cracked concrete	1	1	1
Cracked concrete	1	1,2	1,4

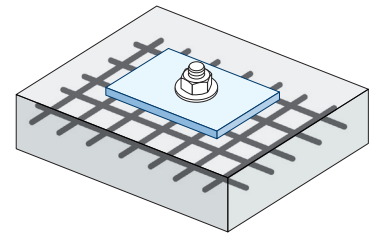

Influence of load application angle $\Psi_{\alpha,v}$											
Angle, $\alpha(^{\circ})$	0°	10°	20°	30°	40°	50°	60°	70°	80°	90°	
$\Psi_{\alpha,v}$	1,00	1,01	1,05	1,13	1,24	1,40	1,64	1,97	2,32	2,50	

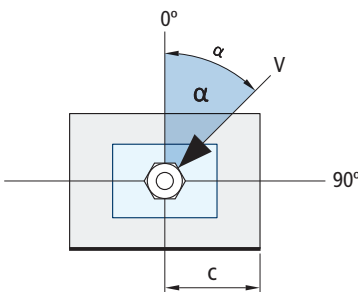

$$\Psi_{\alpha,v} = \sqrt{\frac{1}{(\cos \alpha_v)^2 + \left(\frac{\sin \alpha_v}{2,5}\right)^2}} \geq 1$$

Influence of base material thickness $\Psi_{h,v}$											
MTP-X											
h/c	0,15	0,30	0,45	0,60	0,75	0,90	1,05	1,20	1,35	$\geq 1,5$	
$\Psi_{h,v}$	0,32	0,45	0,55	0,63	0,71	0,77	0,84	0,89	0,95	1,00	

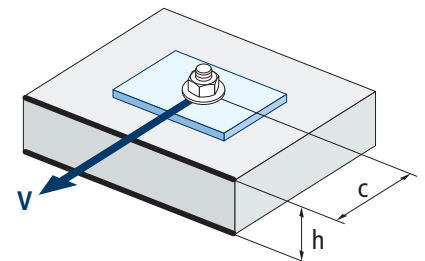

$$\Psi_{h,v} = \left(\frac{h}{1,5 \cdot c}\right)^{0,5} \geq 1,0$$



# MTP-X

## FIRE RESISTANCE

Characteristic Resistance*										
	TENSION					SHEAR				
	M8	M10	M12	M16	M20	M8	M10	M12	M16	M20
RF30	0,4	0,9	1,7	3,1	4,9	0,4	0,9	1,7	3,1	4,9
RF60	0,3	0,8	1,3	2,4	3,7	0,3	0,8	1,3	2,4	3,7
RF90	0,3	0,6	1,1	2,0	3,2	0,3	0,6	1,1	2,0	3,2
RF120	0,2	0,5	0,8	1,6	2,5	0,2	0,5	0,8	1,6	2,5

\*The safety factor for design resistance under fire exposure is  $\gamma_{M,fi}=1$  (in absence of other national regulations). As a result the Characteristic Resistance is the same as Design Resistance.

Maximum Load Recommended										
	TENSION					SHEAR				
	M8	M10	M12	M16	M20	M8	M10	M12	M16	M20
RF30	0,3	0,6	1,2	2,2	3,5	0,3	0,6	1,2	2,2	3,5
RF60	0,2	0,6	0,9	1,7	2,6	0,2	0,6	0,9	1,7	2,6
RF90	0,2	0,4	0,8	1,4	2,3	0,2	0,4	0,8	1,4	2,3
RF120	0,1	0,4	0,6	1,1	1,8	0,1	0,4	0,6	1,1	1,8

## RANGE

Code	Seismic assessment	Size	Maximum thickness of fixture	Axle letter (length)			Code	Seismic assessment	Size	Maximum thickness of fixture	Axle letter (length)		
• APX08050	-	M8 x 50 Ø8	2	A	100	800	APX12120	C1&C2	M12 x 120 Ø12	24	G	50	200
APX08075	C1	M8 x 75 Ø8	9	C	100	600	APX12130	C1&C2	M12 x 130 Ø12	34	H	50	200
APX08080	C1	M8 x 80 Ø8	14	D	100	600	APX12150	C1&C2	M12 x 150 Ø12	54	I	50	100
APX08095	C1	M8 x 95 Ø8	29	E	100	600	APX12180	C1&C2	M12 x 180 Ø12	84	L	50	150
APX08115	C1	M8 x 115 Ø8	49	G	100	400	APX12200	C1&C2	M12 x 200 Ø12	104	M	50	150
APX10090	C1&C2	M10 x 90 Ø10	10	E	100	400	APX12220	C1&C2	M12 x 220 Ø12	124	O	25	50
APX10105	C1&C2	M10 x 105 Ø10	25	F	50	300	APX12255	C1&C2	M12 x 255 Ø12	159	R	25	50
APX10115	C1&C2	M10 x 115 Ø10	35	G	50	200	APX16145	C1	M16 x 145 Ø16	28	I	25	100
APX10135	C1&C2	M10 x 135 Ø10	55	H	50	200	APX16175	C1	M16 x 175 Ø16	58	K	25	50
APX10165	C1&C2	M10 x 165 Ø10	85	K	50	200	APX16220	C1	M16 x 220 Ø16	103	O	25	50
APX10185	C1&C2	M10 x 185 Ø10	105	L	50	150	APX16250	C1	M16 x 250 Ø16	133	Q	25	50
• APX12080	-	M12 x 80 Ø12	4	D	50	300	APX20170	C1&C2	M20 x 170 Ø20	32	K	20	40
APX12100	C1&C2	M12 x 100 Ø12	4	E	50	200	APX20200	C1&C2	M20 x 200 Ø20	62	M	20	40
APX12110	C1&C2	M12 x 110 Ø12	14	F	50	200							

• Non assessed sizes. Resistance values and installation data are not applicable to these references. For further information, please contact Technical Department.