



Through-bolt expansion anchor with controlled torque, for use in cracked and non cracked concrete

MTP-AT

ETA Assessed Option 1. Atlantis shaft. A4 Stainless clip.



PRODUCT INFORMATION

DESCRIPTION

Metallic anchor, with male thread, expansion by controlled torque.

OFFICIAL DOCUMENTATION

- AVCP-1219-CPR-0053.
- ETA 12/0397 option 1.
- Declaration of Performance DoP MTP.

SIZES

M8x50 to M20x200.

DESIGN LOAD RANGE

From 5,0 to 30,6 kN [non cracked].
From 2,8 to 19,4 kN [cracked].



BASE MATERIAL

Concrete class from C20/25 to C50/60
cracked or non-cracked.



Stone



Concrete



Reinforced Concrete



Cracked Concrete

ASSESSMENTS

- Option 1 [Cracked and non-cracked concrete]
- Fire Resistance R30-120
- Seismic C1 M10 ÷ M16
- Seismic C2 M12 ÷ M16



CHARACTERISTICS AND BENEFITS

- Easy installation.
- Use in cracked and non-cracked concrete.
- Use for medium-heavy duty loads.
- Pre-installation or through the drill-hole of the fixture.
- Variety of lengths and diameters: flexibility in assembly.
- For static and quasi-static loads.
- Available at INDEXcal.



MATERIALS

Shaft: Cold-formed steel, Atlantis $\geq 8 \mu\text{m}$.

Washer: DIN 125 or DIN 9021, Atlantis $\geq 8 \mu\text{m}$.

Nut: DIN 934, Atlantis $\geq 8 \mu\text{m}$.

Clip: A4 Stainless steel



APPLICATIONS

- Anchor plates.
- Metallic structures.
- Bridges.
- Urban fitments.
- Protective fences.
- Catenaries.
- Elevators.
- Pipe supports.

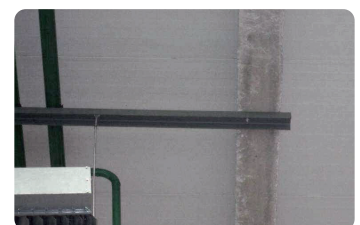



MECHANICAL PROPERTIES

			M8	M10	M12	M16	M20
Cone area section							
A_s	(mm ²)	Cone area section	22,9	41,8	55,4	103,9	176,7
$f_{u,s}$	(N/mm ²)	Characteristic tension resistance	790	750	730	700	660
$f_{y,s}$	(N/mm ²)	Yield strength	632	600	585	560	530
Threaded area section							
A_s	(mm ²)	Cone area section	36,6	58,0	84,3	157,0	245,0
$f_{u,s}$	(N/mm ²)	Characteristic tension resistance	600	600	600	600	600
$f_{y,s}$	(N/mm ²)	Yield Strength	480	480	480	480	480

INSTALLATION DATA

SIZE			M8	M10	M12	M16	M20
Code			AP08XXX	AP10XXX	AP12XXX	AP16XXX	AP20XXX
d_0	Nominal diameter of drill bit	[mm]	8	10	12	16	20
T_{ins}	Installation torque moment	[Nm]	20	40	60	100	200
$d_{f\leq}$	Diameter of clearance hole in the fixture	[mm]	9	12	14	18	22
h_1	Minimum drill hole depth	[mm]	60	75	85	105	125
h_{nom}	Installation depth	[mm]	55	68	80	97	114
h_{ef}	Effective embedment depth	[mm]	48	60	70	85	100
h_{min}	Minimum base material thickness	[mm]	100	120	140	170	200
t_{fix}	Maximum thickness of fixture	[mm]	L - 66	L - 80	L - 96	L - 117	L-138
$S_{cr,N}$	Critical spacing	[mm]	144	180	210	255	300
$C_{cr,N}$	Critical edge distance	[mm]	72	90	105	128	150
$S_{cr,sp}$	Critical distance (splitting)	[mm]	288	300	350	425	500
$C_{cr,sp}$	Critical edge distance (splitting)	[mm]	144	150	175	213	250
S_{min}	Minimum spacing	[mm]	40	40	60	65	95
C_{min}	Minimum edge distance	[mm]	45	45	55	70	95
C_{min}	Minimum edge distance	[mm]	55	90	110	115	105
SW	Installation wrench		13	17	19	24	30

*L = Total anchor length

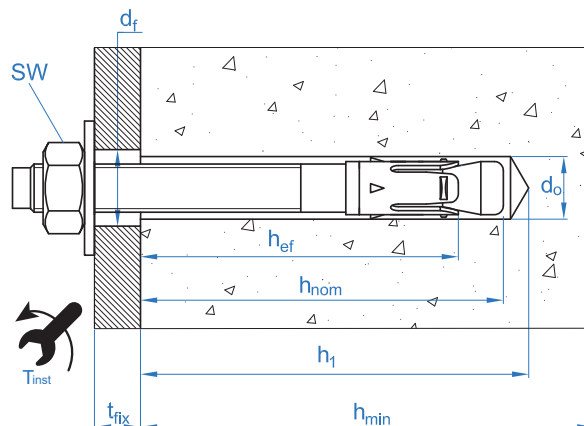

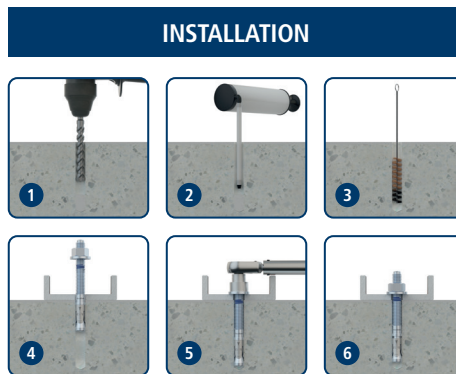

Code	INSTALLATION PRODUCTS
	Hammer drill
BHDSXXXXX	Concrete Drill bits
MOBOMBA	Blow pump
MORCEPKIT	Cleaning Brush
DOMTAXX	Installation hammering tool
	Torque wrench
	Hexagonal socket

**MTP-AT**

Resistances in C20/25 concrete for an isolated anchor, without effects of edge distance or spacing

Characteristic Resistance N_{Rk} and V_{Rk}													
TENSION							SHEAR						
Size		M8	M10	M12	M16	M20	Size		M8	M10	M12	M16	M20
N_{Rk}	Non-cracked concrete [kN]	9,0	18,0	20,0	36,0	48,0	V_{Rk}	Non-cracked concrete [kN]	11,0	17,4	25,3	47,1	73,1
N_{Rk}	Cracked concrete [kN]	5,0	9,5	12,0	25,0	32,0	V_{Rk}	Cracked concrete [kN]	11,5	17,4	25,3	53,9	68,8

Design Resistance N_{Rd} and V_{Rd}													
TENSION							SHEAR						
Size		M8	M10	M12	M16	M20	Size		M8	M10	M12	M16	M20
N_{Rd}	Non-cracked concrete [kN]	5,0	12,0	13,3	24,0	32,0	V_{Rd}	Non-cracked concrete [kN]	8,8	13,9	20,2	37,7	58,5
N_{Rd}	Cracked concrete [kN]	2,8	6,3	8,0	16,7	21,3	V_{Rd}	Cracked concrete [kN]	7,6	13,9	20,2	35,9	45,9

Maximum Loads Recommended N_{rec} and V_{rec}													
TENSION							SHEAR						
Size		M8	M10	M12	M16	M20	Size		M8	M10	M12	M16	M20
N_{rec}	Non-cracked concrete [kN]	3,6	8,6	9,5	17,1	22,9	V_{rec}	Non-cracked concrete [kN]	6,3	9,9	14,5	26,9	41,8
N_{rec}	Cracked concrete [kN]	2,0	4,5	5,7	11,9	15,2	V_{rec}	Cracked concrete [kN]	5,4	9,9	14,5	25,7	32,8

Simplified calculation method

European Technical Assessment ETA 12/0397

Simplified version of the calculation method according to Eurocode 2 EN 1992-4. Resistance is calculated according to the data shown in assessment 12/0397.

- Influence of concrete strength.
- Influence of edge distance.
- Influence of spacing between anchors.
- Influence of reinforcements.
- Influence of base material thickness.
- Influence of load application angle.
- Valid for a group of two anchors.



INDEXcal

For a more accurate calculation and to take more constructive provisions into account, we recommend using our calculation program INDEXcal. It may be easily downloaded from our website www.indexfix.com



MTP-AT

TENSION LOADS

- Steel design resistance: $N_{Rd,s}$
- Pull-out design resistance: $N_{Rd,p} = N_{Rd,p}^o \cdot \Psi_c$
- Concrete cone design resistance: $N_{Rd,c} = N_{Rd,c}^o \cdot \Psi_b \cdot \Psi_{s,N} \cdot \Psi_{c,N} \cdot \Psi_{re,N}$
- Concrete splitting design resistance: $N_{Rd,sp} = N_{Rd,c}^o \cdot \Psi_b \cdot \Psi_{s,sp} \cdot \Psi_{c,sp} \cdot \Psi_{re,N} \cdot \Psi_{h,sp}$

Steel Design resistance							
$N_{Rd,s}$							
Size			M8	M10	M12	M16	M20
N_{Rd}^o	Non-cracked concrete	[kN]	12,1	20,9	26,9	48,5	77,7

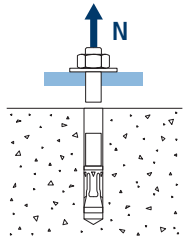

Pull-out design resistance							
$N_{Rd,p} = N_{Rd,p}^o \cdot \Psi_c$							
Size			M8	M10	M12	M16	M20
$N_{Rd,p}^o$	Non-cracked concrete	[kN]	5,00	12,00	13,33	24,00	32,00
$N_{Rd,p}^o$	Cracked concrete	[kN]	2,78	6,33	8,00	16,67	21,33

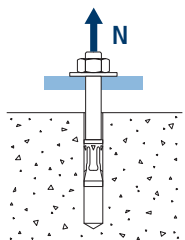

Concrete cone design resistance							
$N_{Rd,c} = N_{Rd,c}^o \cdot \Psi_b \cdot \Psi_{s,N} \cdot \Psi_{c,N} \cdot \Psi_{re,N}$							
Concrete splitting design resistance*							
$N_{Rd,sp} = N_{Rd,c}^o \cdot \Psi_b \cdot \Psi_{s,sp} \cdot \Psi_{c,sp} \cdot \Psi_{re,N} \cdot \Psi_{h,sp}$							
Size			M8	M10	M12	M16	M20
$N_{Rd,c}^o$	Non-cracked concrete	[kN]	9,1	15,2	19,2	25,7	32,8
$N_{Rd,c}^o$	Cracked concrete	[kN]	6,4	10,7	13,5	18,0	23,0

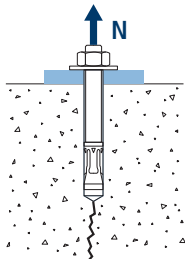
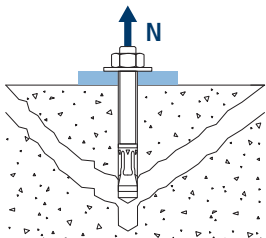

*Concrete splitting design resistance must only be considered for non-cracked concrete.



MTP-AT

Coefficients of influence

Influence of concrete strength resistance in pul-out failure Ψ_c

		M8	M10	M12	M16	M20
Ψ_c	C 20/25	1,00				
	C 30/37	1,22	1,17	1,22	1,22	1,17
	C 40/50	1,41	1,31	1,41	1,41	1,31
	C 50/60	1,58	1,43	1,58	1,58	1,43

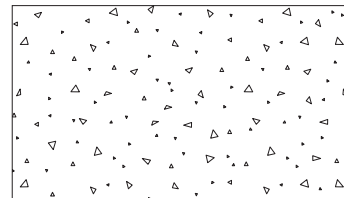
Influence of concrete strength in concret cone and splitting failure Ψ_b

		M8	M10	M12	M16	M20
Ψ_b	C 20/25	1,00				
	C 30/37	1,22				
	C 40/50	1,41				
	C 50/60	1,58				

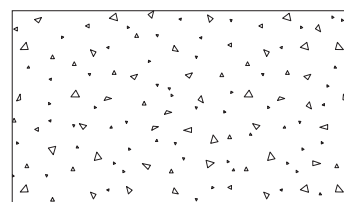

$$\Psi_b = \sqrt{\frac{f_{ck,cube}}{25}} \geq 1$$



MTP-AT



$$\psi_{s,N} = 0,5 + \frac{s}{2 \cdot s_{cr,N}} \leq 1$$

Influence of spacing (concrete cone) $\psi_{s,N}$					
s [mm]	MTP-AT				
	M8	M10	M12	M16	M20
40	0,64	0,61			
50	0,67	0,64			
55	0,69	0,65			Invalid value
60	0,71	0,67	0,64		
65	0,73	0,68	0,65	0,63	
70	0,74	0,69	0,67	0,64	
80	0,78	0,50	0,50	0,66	
85	0,80	0,74	0,70	0,67	
90	0,81	0,75	0,71	0,68	
95	0,83	0,76	0,73	0,69	0,66
100	0,85	0,78	0,74	0,70	0,67
105	0,86	0,79	0,75	0,71	0,68
110	0,88	0,81	0,76	0,72	0,68
120	0,92	0,83	0,79	0,74	0,70
125	0,93	0,85	0,80	0,75	0,71
126	0,94	0,85	0,80	0,75	0,71
128	0,94	0,86	0,80	0,75	0,71
130	0,95	0,86	0,81	0,75	0,72
135	0,97	0,88	0,82	0,76	0,73
144	1,00	0,90	0,84	0,78	0,74
150		0,92	0,86	0,79	0,75
165		0,96	0,89	0,82	0,78
170		0,97	0,90	0,83	0,78
180		1,00	0,93	0,85	0,80
195			0,96	0,88	0,83
200			0,98	0,89	0,83
210			1,00	0,91	0,85
220				0,93	0,87
225				0,94	0,88
252				0,99	0,92
255				1,00	0,93
260					0,93
300					1,00
309					
310					
375					

Value without reduction = 1



Influence of spacing (concrete splitting) $\psi_{s,sp}$								
s [mm]	MTP-AT							
	M8	M10	M12	M16	M20			
40	0,57	0,57	Invalid value					
50	0,59	0,58						
55	0,60	0,59						
60	0,60	0,60	0,59	Invalid value				
65	0,61	0,61	0,59			0,58		
70	0,62	0,62	0,60			0,58		
80	0,64	0,63	0,61	0,59	Invalid value			
85	0,65	0,64	0,62	0,60				
90	0,66	0,65	0,63	0,61				
95	0,66	0,66	0,64	0,61	0,60			
100	0,67	0,67	0,64	0,62	0,60			
110	0,69	0,68	0,66	0,63	0,61			
125	0,72	0,71	0,68	0,65	0,63			
128	0,72	0,71	0,68	0,65	0,63			
135	0,73	0,73	0,69	0,66	0,64			
140	0,74	0,73	0,70	0,66	0,64			
150	0,76	0,75	0,71	0,68	0,65			
160	0,78	0,77	0,73	0,69	0,66			
165	0,79	0,78	0,74	0,69	0,67			
168	0,79	0,78	0,74	0,70	0,67			
180	0,81	0,80	0,76	0,71	0,68			
192	0,83	0,82	0,77	0,73	0,69			
200	0,85	0,83	0,79	0,74	0,70			
210	0,86	0,85	0,80	0,75	0,71			
220	0,88	0,87	0,81	0,76	0,72			
260	0,95	0,93	0,87	0,81	0,76			
280	0,99	0,97	0,90	0,83	0,78			
288	1,00	0,98	0,91	0,84	0,79			
300	Value without reduction = 1		0,93	0,85	0,80			
336			0,98	0,90	0,84			
350			1,00	0,91	0,85			
360	Value without reduction = 1		Value without reduction = 1		0,92	0,86		
412					0,98	0,91		
425					1,00	0,93		
500	Value without reduction = 1		Value without reduction = 1		1,00	1,00		
510					Value without reduction = 1		Value without reduction = 1	
560								

MTP-AT

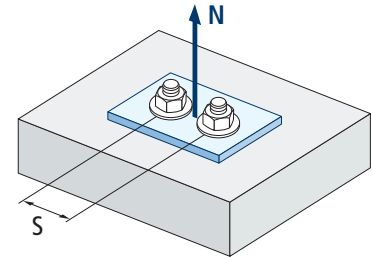

$$\psi_{s,sp} = 0,5 + \frac{s}{2 \cdot s_{cr,sp}} \leq 1$$



MTP-AT



$$\psi_{c,sp} = 0,35 + \frac{0,5 \cdot c}{C_{cr,sp}} + \frac{0,15 \cdot c^2}{C_{cr,sp}^2} \leq 1$$

Influence of concrete edge distance (splitting) $\psi_{c,sp}$					
c [mm]	MTP-AT				
	M8	M10	M12	M16	M20
45	0,52	0,51			
50	0,54	0,53			
55	0,56	0,55	0,52		Invalid value
60	0,58	0,57	0,54		
65	0,61	0,59	0,56		
70	0,63	0,62	0,57	0,53	
75	0,65	0,64	0,59	0,54	
80	0,67	0,66	0,61	0,56	
83	0,69	0,67	0,62	0,57	
84	0,69	0,68	0,62	0,57	
85	0,70	0,68	0,63	0,57	
90	0,72	0,70	0,65	0,59	
95	0,75	0,73	0,67	0,60	0,56
100	0,77	0,75	0,68	0,62	0,57
105	0,79	0,77	0,70	0,63	0,59
110	0,82	0,80	0,72	0,65	0,60
125	0,90	0,87	0,78	0,70	0,64
128	0,91	0,89	0,80	0,70	0,65
130	0,92	0,90	0,80	0,71	0,65
135	0,95	0,92	0,82	0,73	0,66
140	0,98	0,95	0,85	0,74	0,68
144	1,00	0,97	0,86	0,76	0,69
150		1,00	0,89	0,78	0,70
168			0,97	0,84	0,75
175			1,00	0,86	0,77
180				0,88	0,79
206				0,97	0,86
213				1,00	0,88
250	Value without reduction = 1				1,00
255					
280					



Influence of concrete edge distance (concrete cone) $\Psi_{c,N}$					
c [mm]	MTP-AT				
	M8	M10	M12	M16	M20
40	0,67	0,60			
50	0,77	0,67			
53	0,80	0,70			
60	0,87	0,75	0,68		
63	0,90	0,77	0,70		
65	0,92	0,79	0,72	0,64	
70	0,98	0,83	0,75	0,67	
72	1,00	0,85	0,76	0,68	
75		0,87	0,78	0,69	
80		0,91	0,82	0,72	
83		0,94	0,84	0,74	
85		0,96	0,85	0,75	
90		1,00	0,89	0,78	
95			0,93	0,80	0,73
100			0,96	0,83	0,75
105			1,00	0,86	0,77
110				0,89	0,80
113				0,91	0,81
125				0,98	0,87
126				0,99	0,88
128				1,00	0,89
135					0,92
150					1,00
155					
188					

Value without reduction = 1

MTP-AT

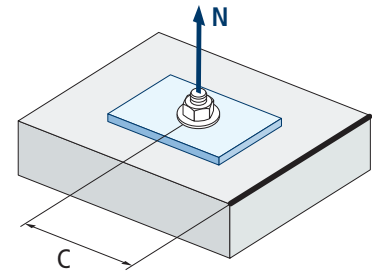

$$\Psi_{c,N} = 0,35 + \frac{0,5 \cdot c}{C_{cr,N}} + \frac{0,15 \cdot c^2}{C_{cr,N}^2} \leq 1$$

Influence of reinforcements $\Psi_{re,N}$					
$\Psi_{re,N}$	MTP-AT				
	M8	M10	M12	M16	M20
	0,74	0,80	0,85	0,93	1,00

*This factor only applies for a high density of reinforcements. If in the area of the anchor there are reinforcements with a distancing of ≥ 150 mm (any diameter) or with a diameter ≤ 10 mm and a distancing of ≥ 100 mm, a $f_{re,N} = 1$ factor may be applied.

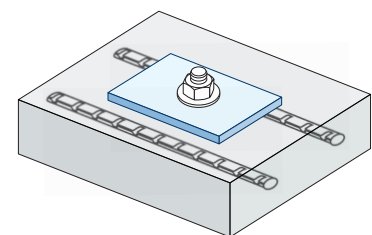

$$\Psi_{re,N} = 0,5 + \frac{h_{ef}}{200} \leq 1$$

Influence of base material thickness $\Psi_{h,sp}$											
$\Psi_{h,sp}$	MTP-AT										
	h/hef	2,00	2,20	2,40	2,60	2,80	3,00	3,20	3,40	3,60	$\geq 3,68$
	$\Psi_{h,sp}$	1,00	1,07	1,13	1,19	1,25	1,31	1,37	1,42	1,48	1,50

$$\Psi_{h,sp} = \left(\frac{h}{2 \cdot h_{ef}} \right)^{2/3} \leq 1,5$$

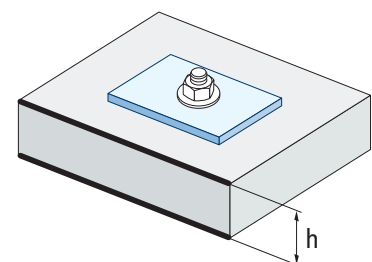



MTP-AT

SHEAR LOADS

- Steel design resistance without lever arm: $V_{Rd,s}$
- Pry-out design resistance: $V_{Rd,cp} = k \cdot N_{Rd,c}^o$
- Concrete edge design resistance: $V_{Rd,c} = V_{Rd,c}^o \cdot \psi_b \cdot \psi_{se,V} \cdot \psi_{c,V} \cdot \psi_{re,V} \cdot \psi_{\alpha,V} \cdot \psi_{h,V}$

Steel design resistance						
$V_{Rd,s}$						
Size		M8	M10	M12	M16	M20
$V_{Rd,s}$	[kN]	8,8	13,9	20,2	37,6	58,8

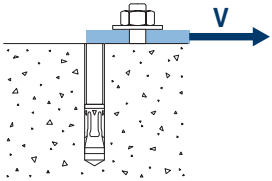

Pry-out design resistance*						
$V_{Rd,cp} = k \cdot N_{Rd,c}^o$						
Size		M8	M10	M12	M16	M20
k		1	2	2	2	2

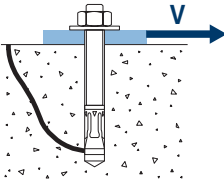

* $N_{Rd,c}^o$ Concrete cone design resistance for tension loads

Concrete edge resistance							
$V_{Rd,c} = V_{Rd,c}^o \cdot \psi_b \cdot \psi_{se,V} \cdot \psi_{c,V} \cdot \psi_{re,V} \cdot \psi_{\alpha,V} \cdot \psi_{h,V}$							
Size		M8	M10	M12	M16	M20	
$V_{Rd,c}^o$	Non-cracked concrete	[kN]	6,2	8,9	11,5	15,9	20,8
	Cracked concrete	[kN]	4,4	6,3	8,2	11,3	14,7

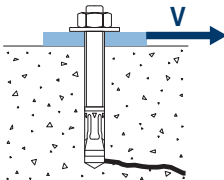



MTP-AT

Coefficients of influence

Influence of concrete strength in concrete edge failure Ψ_b

		M8	M10	M12	M16	M20
Ψ_b	C 20/25			1,00		
	C 30/37			1,22		
	C 40/50			1,41		
	C 50/60			1,55		

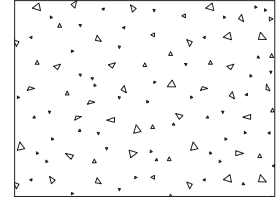

$$\Psi_b = \sqrt{\frac{f_{ck,cube}}{25}} \geq 1$$

Influence of edge distance and spacing $\Psi_{se,V}$

FOR ONE ANCHOR ONLY

c/h_{ef}	0,50	0,75	1,00	1,25	1,50	1,75	2,00	2,25	2,50	2,75	3,00	3,25	3,50	3,75	4,00	4,50	5,00
Isolated	0,35	0,65	1,00	1,40	1,84	2,32	2,83	3,38	3,95	4,56	5,20	5,86	6,55	7,26	8,00	9,55	11,18

FOR TWO ANCHORS

c/h_{ef}	0,50	0,75	1,00	1,25	1,50	1,75	2,00	2,25	2,50	2,75	3,00	3,25	3,50	3,75	4,00	4,50	5,00	
s/c	1,0	0,24	0,43	0,67	0,93	1,22	1,54	1,89	2,25	2,64	3,04	3,46	3,91	4,37	4,84	5,33	6,36	7,45
	1,5	0,27	0,49	0,75	1,05	1,38	1,74	2,12	2,53	2,96	3,42	3,90	4,39	4,91	5,45	6,00	7,16	8,39
	2,0	0,29	0,54	0,83	1,16	1,53	1,93	2,36	2,81	3,29	3,80	4,33	4,88	5,46	6,05	6,67	7,95	9,32
	2,5	0,32	0,60	0,92	1,28	1,68	2,12	2,59	3,09	3,62	4,18	4,76	5,37	6,00	6,66	7,33	8,75	10,25
	≥3,0	0,35	0,65	1,00	1,40	1,84	2,32	2,83	3,38	3,95	4,56	5,20	5,86	6,55	7,26	8,00	9,55	11,18

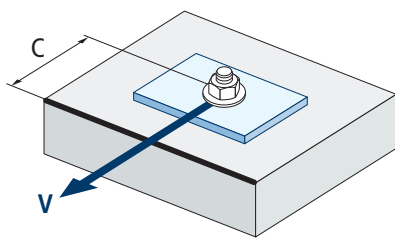

$$\Psi_{se,V} = \left(\frac{c}{h_{ef}}\right)^{1,5}$$

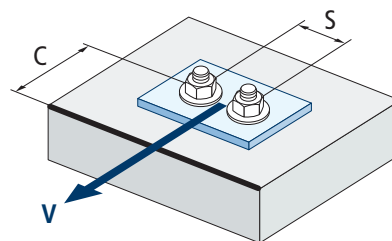

$$\Psi_{se,V} = \left(\frac{c}{h_{ef}}\right)^{1,5} \cdot \left(1 + \frac{s}{3 \cdot c}\right) \cdot 0,5 \leq \left(\frac{c}{h_{ef}}\right)^{1,5}$$



MTP-AT

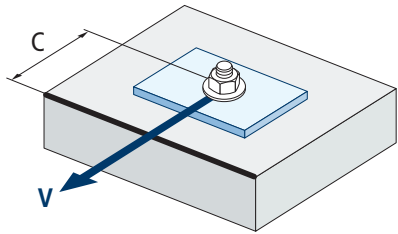

$$\psi_{c,v} = \left(\frac{d}{c} \right)^{0,20}$$

Influence of concrete edge distance $\psi_{c,v}$					
c [mm]	MTP-AT				
	M8	M10	M12	M16	M20
40					
45					
50	0,69				Invalid value
55	0,68				
60	0,67	0,70			
65	0,66	0,69	0,71		
70	0,65	0,68	0,70		
80	0,63	0,66	0,68		
85	0,62	0,65	0,68	0,72	
90	0,62	0,64	0,67	0,71	
100	0,60	0,63	0,65	0,69	0,72
105	0,60	0,62	0,65	0,69	0,72
110	0,59	0,62	0,64	0,68	0,71
120	0,58	0,61	0,63	0,67	0,70
125	0,58	0,60	0,63	0,66	0,69
130	0,57	0,60	0,62	0,66	0,69
135	0,57	0,59	0,62	0,65	0,68
140	0,56	0,59	0,61	0,65	0,68
150	0,56	0,58	0,60	0,64	0,67
160	0,55	0,57	0,60	0,63	0,66
170	0,54	0,57	0,59	0,62	0,65
175	0,54	0,56	0,59	0,62	0,65
180	0,54	0,56	0,58	0,62	0,64
190	0,53	0,55	0,58	0,61	0,64
200	0,53	0,55	0,57	0,60	0,63
210	0,52	0,54	0,56	0,60	0,62
220	0,52	0,54	0,56	0,59	0,62
230	0,51	0,53	0,55	0,59	0,61
240	0,51	0,53	0,55	0,58	0,61
250	0,50	0,53	0,54	0,58	0,60
260	0,50	0,52	0,54	0,57	0,60
270	0,49	0,52	0,54	0,57	0,59
280	0,49	0,51	0,53	0,56	0,59
290	0,49	0,51	0,53	0,56	0,59
300	0,48	0,51	0,53	0,56	0,58



Influence of reinforcements $\Psi_{re,v}$			
	Without perimetral reinforcements	Perimetral reinforcements $\geq \text{Ø}12 \text{ mm}$	Perimetral reinforcements with brackets $\leq 100 \text{ mm}$
Non-cracked concrete	1	1	1
Cracked concrete	1	1,2	1,4

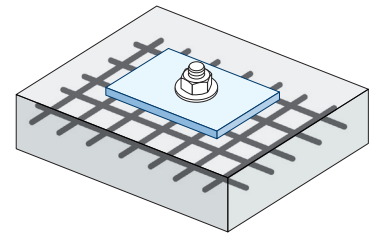

Influence of load application angle $\Psi_{\alpha,v}$											
Angle, $\alpha(^{\circ})$	0°	10°	20°	30°	40°	50°	60°	70°	80°	90°	
$\Psi_{\alpha,v}$	1,00	1,01	1,05	1,13	1,24	1,40	1,64	1,97	2,32	2,50	

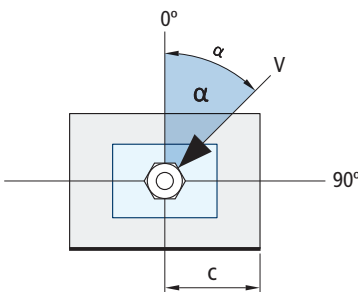

$$\Psi_{\alpha,v} = \sqrt{\frac{1}{(\cos \alpha_v)^2 + \left(\frac{\sin \alpha_v}{2,5}\right)^2}} \geq 1$$

Influence of base material thickness $\Psi_{h,v}$											
MTP-AT											
h/c	0,15	0,30	0,45	0,60	0,75	0,90	1,05	1,20	1,35	$\geq 1,5$	
$\Psi_{h,v}$	0,32	0,45	0,55	0,63	0,71	0,77	0,84	0,89	0,95	1,00	

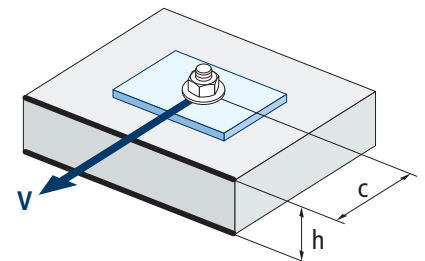

$$\Psi_{h,v} = \left(\frac{h}{1,5 \cdot c}\right)^{0,5} \geq 1,0$$



MTP-AT

FIRE RESISTANCE

Characteristic Resistance*										
	TENSION					SHEAR				
	M8	M10	M12	M16	M20	M8	M10	M12	M16	M20
RF30	0,4	0,9	1,7	3,1	4,9	0,4	0,9	1,7	3,1	4,9
RF60	0,3	0,8	1,3	2,4	3,7	0,3	0,8	1,3	2,4	3,7
RF90	0,3	0,6	1,1	2,0	3,2	0,3	0,6	1,1	2,0	3,2
RF120	0,2	0,5	0,8	1,6	2,5	0,2	0,5	0,8	1,6	2,5

*The safety factor for design resistance under fire exposure is $\gamma_{M,fi}=1$ (in absence of other national regulations). As a result the Characteristic Resistance is the same as Design Resistance.

Maximum Load Recommended										
	TENSION					SHEAR				
	M8	M10	M12	M16	M20	M8	M10	M12	M16	M20
RF30	0,3	0,6	1,2	2,2	3,5	0,3	0,6	1,2	2,2	3,5
RF60	0,2	0,6	0,9	1,7	2,6	0,2	0,6	0,9	1,7	2,6
RF90	0,2	0,4	0,8	1,4	2,3	0,2	0,4	0,8	1,4	2,3
RF120	0,1	0,4	0,6	1,1	1,8	0,1	0,4	0,6	1,1	1,8

RANGE

Code	Seismic assessment	Size	Maximum thickness of fixture	Axle letter (length)			Code	Seismic assessment	Size	Maximum thickness of fixture	Axle letter (length)		
APAT08075	-	M8 x 75 Ø8	9	C	100	600	APAT12120	C1&C2	M12 x 120 Ø12	24	G	50	200
APAT08095	-	M8 x 95 Ø8	29	E	100	600	APAT12130	C1&C2	M12 x 130 Ø12	34	H	50	200
APAT08115	-	M8 x 115 Ø8	49	G	100	400	APAT12150	C1&C2	M12 x 150 Ø12	54	I	50	100
APAT10090	C1	M10 x 90 Ø10	10	E	100	400	APAT12180	C1&C2	M12 x 180 Ø12	84	L	50	150
APAT10105	C1	M10 x 105 Ø10	25	F	50	300	APAT12200	C1&C2	M12 x 200 Ø12	104	M	50	150
APAT10115	C1	M10 x 115 Ø10	35	G	50	200	APAT16145	C1&C2	M16 x 145 Ø16	28	I	25	100
APAT10135	C1	M10 x 135 Ø10	55	H	50	200	APAT16175	C1&C2	M16 x 175 Ø16	58	K	25	50
APAT10165	C1	M10 x 165 Ø10	85	K	50	200	APAT16220	C1&C2	M16 x 220 Ø16	103	O	25	50
APAT10185	C1	M10 x 185 Ø10	105	L	50	150	APAT20170	-	M20 x 170 Ø20	32	K	20	40
APAT12100	C1&C2	M12 x 100 Ø12	4	E	50	200	APAT20200	-	M20 x 200 Ø20	62	N	20	40
APAT12110	C1&C2	M12 x 110 Ø12	14	F	50	200							